

★ *City of* ★  
**BELLEVILLE**

== HERITAGE GUIDE ==

*Walking Tours*



*Heritage Sites*

— EST. 1816 —

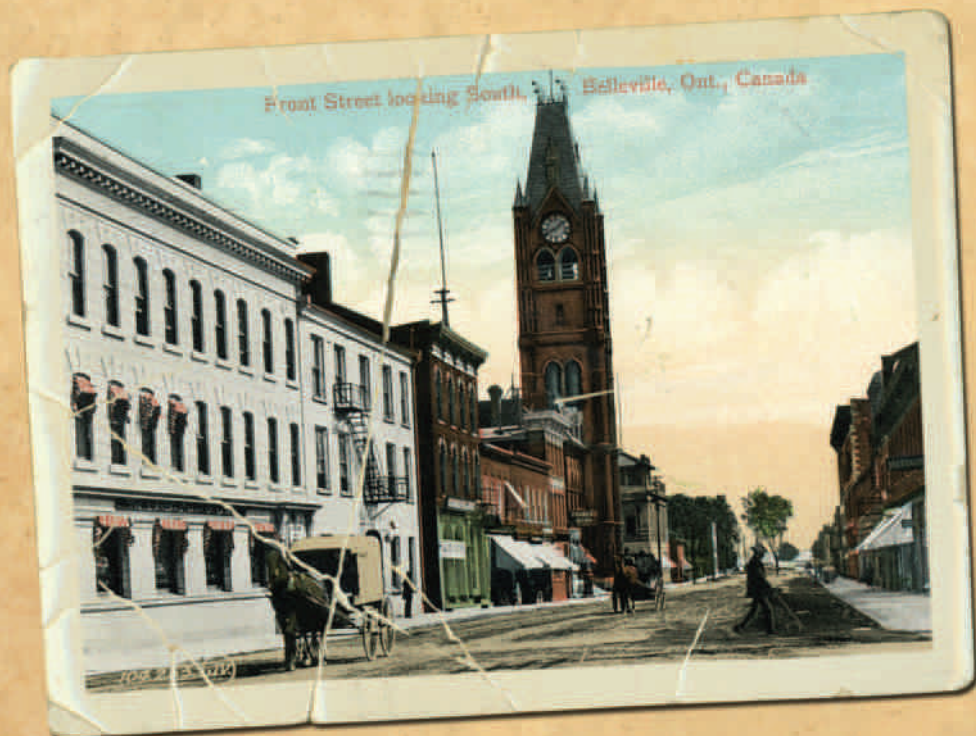

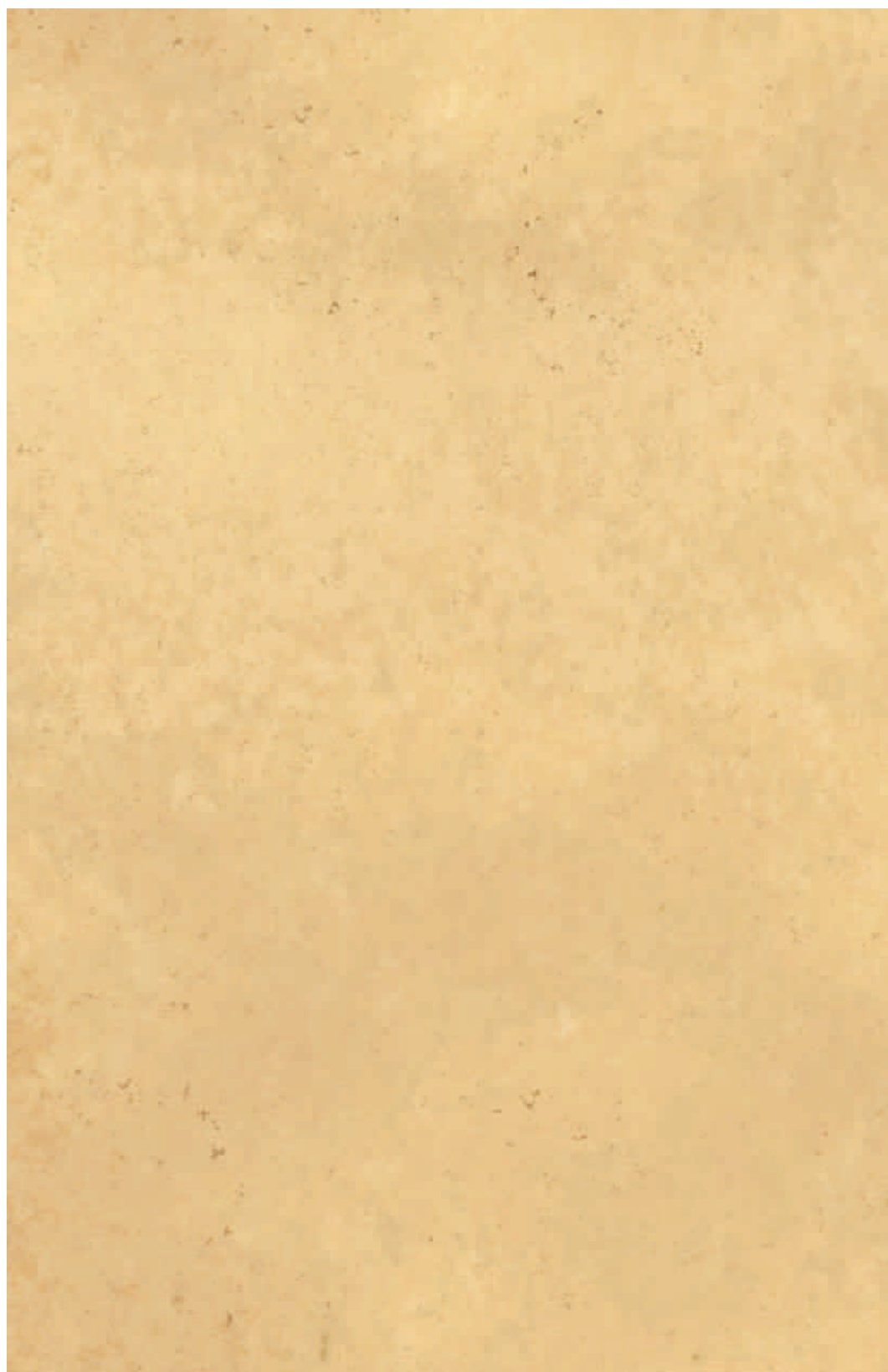

# Contents

Historical Information .....	4
City Hall .....	5
Designated Sites Walking Tour .....	11
Places of Worship Walking Tour .....	24
Designation Plaques .....	30

## Heritage Belleville

This brochure was developed by Heritage Belleville.

Heritage Belleville is our municipal heritage committee and is comprised of citizens appointed to the committee who are interested and knowledgeable about heritage matters.

### Our Mandate:

The Function of the committee is to advise Belleville City Council on local heritage matters and assist them in carrying out heritage conservation programs. Prior to the Government Efficiency Act, 2002, Heritage Belleville was known as the Local Architectural Conservation Advisory Committee, or LACAC.

The Ontario Heritage Act, 1990 - section 28 (1) states: "The council of a municipality may by by-law establish a municipal heritage committee to advise and assist the council on matters relating to this Part, matters relating to Part V and such other heritage matters as the council may specify by by-law." The parts of the act mentioned include the conservation of property which is of cultural heritage value or interest, and the administration of heritage conservation districts

A Designated & Listing Information Guide is available at City Hall.

### For more Information:

Heritage Belleville, C/O City Hall, 169 Front Street, Belleville Ontario K8N 2Y8

Telephone: (613) 968 6481, ext. 3260

Email: [contact@heritagebelleville.ca](mailto:contact@heritagebelleville.ca)

# The History of Belleville

The earliest known settlement was an Indian village, "Asaukhknosk," replaced by a French Mission "Kente," and thereafter named for prominent citizens, "Thurlow Village," "Singleton's Creek" and "Meyers' Creek."

In 1789 some fifty United Empire Loyalists settled here. The most notable was Captain John Walden Meyers, a true renaissance man. Hardworking and resourceful, he built a dam on the Moira River and erected a sawmill, a gristmill and a distillery. Meyers operated a trading post and a brick kiln. He is credited with building the first brick house in Upper Canada in 1794. Meyers' gristmill drew settlers from Napanee to Port Hope to have their grinding done and the community soon became known as Meyers' Creek.

The Moira River, which winds its way through the city, played an important role in the early stages of the community's development. A strong demand for timber in England led to Belleville's development as a bustling lumber town. Rich forests nearby were easily accessible by the river and French Canadian loggers were a familiar sight in the community. The logs were cut into timber at several local mills and loaded on schooners or were rafted and taken down the St. Lawrence to Quebec.

With its export trade in lumber and flour Belleville's harbour was alive with vessels of every description. Belleville soon gained the reputation as the most prosperous town in Upper Canada.

A visit in the spring of 1816, by Sir Francis Gore, Lieutenant-Governor of Upper Canada and his wife, Lady Arabella, inspired the residents to change the name of their



settlement to Belleville in honour of the fair lady.

The lumber boom peaked and the arrival of the Grand Trunk Railway in 1856 gave Belleville a link with Montreal and Toronto. For many years the railway was Belleville's largest employer. In 1866, discovery of gold near Madoc, earned Belleville the name "Gateway to the Golden North" as miners stopped for supplies on their way north of the city.

While the lumber trade declined towards the end of the nineteenth century industries were expanding. Handcrafted, pioneered items gave way to factory made goods. Iron foundries, furniture manufacturers, plants producing wagons, carriages, candles and soap abounded. Situated in the centre of a cheese-producing district Belleville became renown for its world-class cheddar.

From the pioneering past to the present vibrant community, Belleville continues to enjoy a diverse industrial base along with strong links to agriculture and its waterfront.

★ *City of* ★  
**BELLEVILLE**  
== CITY HALL ==  
*Self-Guided Tour*



# Belleville City Hall Walking Tour

## City Hall Background Information

In 1871, Mayor Holden proposed that a larger market building would attract people to the town centre and fulfil the community's needs for a fire bell and town clock. Plans were immediately underway to raise funds, and to hire an architect and builder to construct this building. It was completed in late 1873. This building, once named the Town Market Building, is now Belleville's City Hall, and is one of the city's most impressive structures. This majestic historical building faces west and overlooks the Moira River.

The architect of City Hall was John Evans and the builder was John Forin. Evans designed the original plans and supervised the construction. Forin was the builder and occasionally modified Evans' plans. Both men built and designed several of Belleville's lovely Victorian buildings.



Belleville's City Hall was completed in 1873 and then renovated in 1988.

# Self guided tour

To begin your tour of City Hall, start by walking around the outside of the building and take in the beautiful architectural features.

You will notice several windows on the first floor that have been bricked in partially or completely. These were the entrances leading to the market area which was housed on the first floor. This building originally had only two floors, with the second housing the auditorium and offices for the town. The first floor was an inside market, which was moved outside by 1961 to become part of the market activities on the present Market Square (immediately to the east of City Hall).

A large back entrance to the building (now only used for staff), was bricked in for many years but, with the 1988 renovations, has been restored. This is why there is an absence of windows above the back entrance. Originally, John Evans planned the construction in phases, with butter and meat markets to be added at a later date.

When you return to the entrance, step back a little and look up at the bell tower, complete with clock. The tower is 144 feet high. The tower bell was cast in 1872 by the firm of John Warner and Sons of London, England.

## First Floor

Just inside the main entrance, there is a plaque identifying the architect as John Evans and the builder as John Forin. A piece of artwork titled *The Banquet in the Town Hall* to the left of the main entrance features Canadian and American teachers of the deaf attending the civic reception in the first floor market in this building on July 16, 1874. The wooden columns and trusses that have been preserved from the original construction can be seen in this image.

Proceed to the waiting area. As you enter the foyer, observe the columns on either side of the entranceway. These are original and the only two that could be saved.

In 1988, City Hall was renovated by Bel-Con Engineering Ltd. They changed City Hall's two floors into four floors, adding over 10,000 square feet of new space. Local businesses and groups donated many new furnishings at that time. In 1997-98, City Hall was renovated again, this time to accommodate the changes due to the amalgamation of Belleville and Thurlow Township.

To the right of the waiting area is the City Clerk's Office and to the left is the Treasury Office.

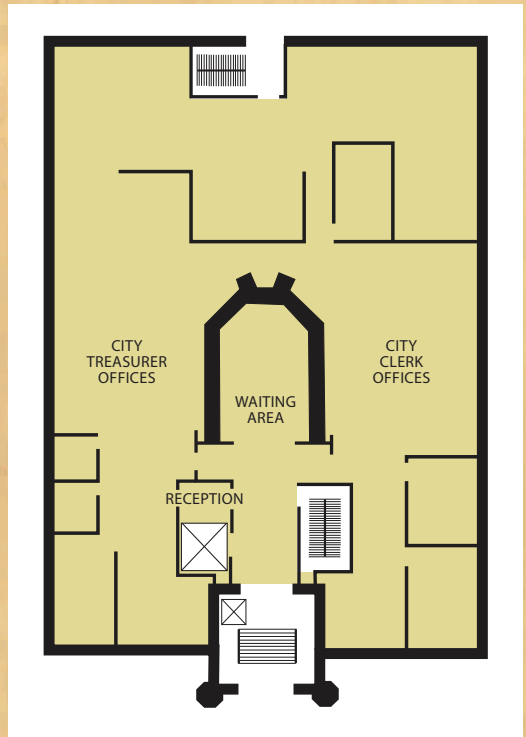

First Floor

On the east wall is the Belleville Coat of Arms, one of two found in City Hall. On June 10, 1992, Governor General Hnatyshyn and his wife participated in a ceremony at City Hall to register the Coat of Arms into the Public Register of Arms, Flags and Badges of Canada. On the shield, there are bells, symbolic of the city's name; water for the Bay of Quinte and Moira River; books for the many religious and educational institutions of the city; and two locomotives for the Grand Trunk and other railways which serviced Belleville. A Mohawk Indian and a pioneer support the shield and symbolize friendship. Above the shield is the flag of St. George (patron saint of England). A golden maple leaf adorns the top of the Coat of Arms. From the eastern desk, look up through the atrium towards the bell tower. This open concept gives a bright, airy and spacious feel to City Hall.

Take the elevator to the third floor.

### Third Floor

In the hallway beside the elevator is a beautiful stained glass window designed by the internationally recognized artist Stephen Belanger-Taylor. The window is an abstract view of Belleville and was presented to City Hall by the Belleville Downtown Improvement Area in 1989.

Walk to the right of the stained glass window and enter the Sir Mackenzie Bowell Room, the largest reception room in City Hall.

Sir Mackenzie Bowell was the owner and editor of *The Intelligencer* from 1848 to 1867, at which time he became involved in federal politics. In 1894, Bowell became the fifth Prime Minister of Canada. His home (at 194 William Street) is marked with an Ontario Heritage Foundation plaque.

Several framed photographs depict Belleville in days gone by. Sir Mackenzie Bowell's photograph is on the north wall near the door.

There are photographs of the Meat Market, which was located at the Northeast corner of the Market Square behind City Hall, where the police department and court room were located for approximately 60 years. Another photograph shows the former Y.M.C.A. building on Campbell Street.

The original bricks, used by Evans and his work crew in 1873, were larger than standard bricks used at that time, which made it difficult when replacing damaged bricks during the renovation in 1988. Notice the framed photograph of Governor General Hnatyshyn and his wife, presented to Belleville during their visit in 1992.

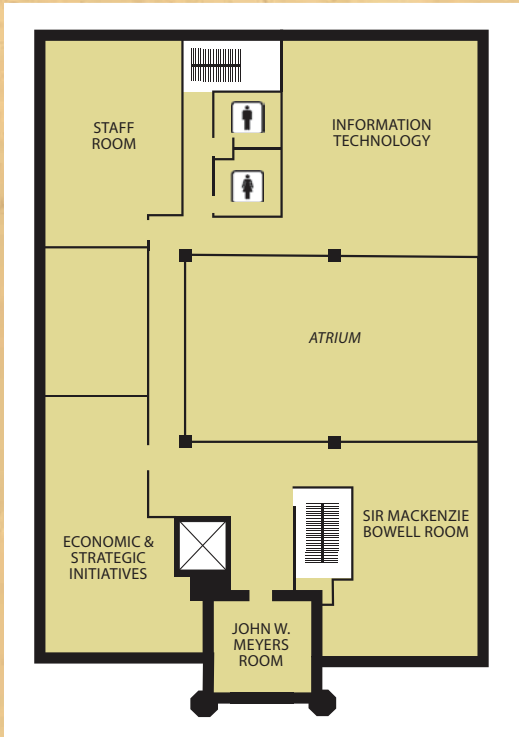

Third Floor



There is a plaque in honour of the ship's company of H.M.C.S. Belleville, a Corvette partially paid for by the local citizens in World War II. Notice the large aerial view of Belleville in 1955. A lot has changed since then, but the most notable feature is that the Dundas Street bridge has not yet been built.

As you return to the hallway, look down the foyer where the elevator is located towards the John Meyers Room. Here you will see a scale model of the H.M.C.S. Belleville that was built by long-time City of Belleville employee Robert E. Ladoucier.

John Meyers established the first mills on the Moira River. These mills served as a centre around which the settlement grew. Meyers was elected as moderator (chairman) of Sidney Township in 1790. One of Belleville's early names was Meyers' Creek. This is the office of Heritage Belleville and contains information on heritage buildings in the city, historic maps and publications of historical interest.

To the left of the stained glass window is the Economic and Strategic Initiatives Office. This area was created from three smaller meeting rooms during the 1998 renovations.

Looking down to the second floor. The second floor is Engineering and Development Services which consists of Engineering, Planning, Building and Approvals. The third floor was created by dividing the original second story in half. Notice the tall windows on the south wall. As the third floor starts, the gothic triangular tops of these windows are present in rooms on the third floor.

Continue down the hall to the Market Room. This is the lunch room for City Hall employees. Washrooms are adjacent to the Market Room.

Return and take the elevator to the fourth floor.

## Fourth Floor

Turn right into the Thomas Holden Room where you can see the Moira River and view the Billa Flint House directly across the Moira River from City Hall. This house was constructed in 1835 and is designated by the City as being historically significant. Mr. Flint was a lumber baron and president of the newly-formed police village of Belleville in 1836. There is also a plaque naming the people involved in the renovations, and two other photographs, one showing City Councillors and the other showing City Department Heads at the time of the re-dedication of City Hall. Also in the Thomas Holden Room on the south wall are photographs of the Mayors from 1850 - 1915. The photos of the Mayors from 1916 to the present are on the west wall outside this room.

There is a tower room on the fifth floor, directly above this one, that is used for a conference room, but it is normally locked. In 1929, the clock weight in the tower fell and crashed through to the second floor office in the tower. Luckily, no one was in the office at the time. To protect people in case the clock weight ever fell again, rubber tires were placed above the ceiling of the second floor office to cushion the weight and break its fall. Fortunately, we never found out if it would work.

As you leave the Thomas Holden Room, proceed towards the main doors to the Council Chamber on your left.

The Mayor's Fauteuil (French for Armchair) is City Hall's only original piece of furniture. The fauteuil was designed and built by John D. Evans and was first used on January 12,

1874. A skylight had to be built to accommodate the intricate design of the canopy. On the south wall, next to the doors, is a collage showing the Council Chamber before 1988, when it was located on the second floor. Further along this wall are the Documents Patent for the City's Coat of Arms. The second set of the Coat of Arms can be seen facing the entrance doors of the Council Chamber.

As you leave the Council Chamber walk around the atrium until you reach the John D. Evans and John Forin rooms. Enter the John D. Evans Room. This room is used for private sessions of Council and has a view of Market Square through the east windows. The large framed photograph of City Hall was donated by Sears Canada Inc. The black granite clock has a fossil in the upper left-hand corner and was a gift from Lahr, Germany on August 8, 1994. Lahr shares a special relationship with Belleville as its first twin city.

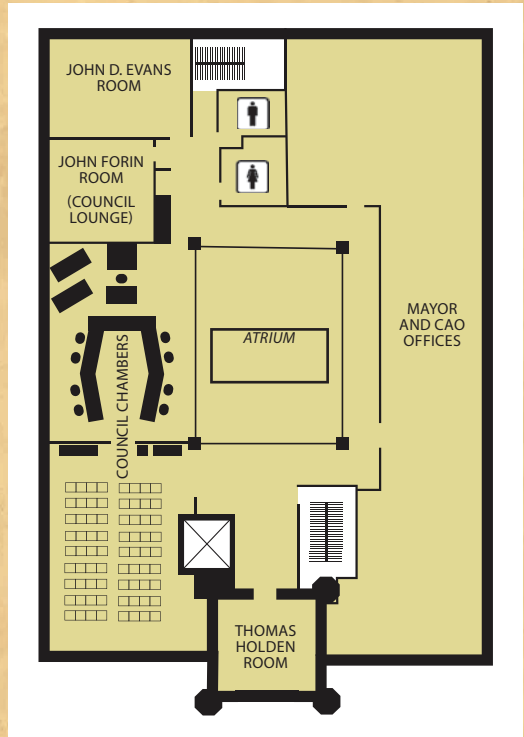

Fourth Floor

As you leave the John D. Evans Room, you will see the John Forin Room on your right. This Room is Council's Private Lounge. On the east wall is a framed picture of John Forin, presented to the City by his grandson, J.P. MacLaren, in 1951. On the west wall, there is a framed collage of photographs from the renovations in 1988, presented by Bel-Con Engineering Ltd. In the centre is William R. White, the engineer and architect of City Hall renovations.

Proceed out of the Room. The large wooden trusses crossing the span of the atrium are part of the original structure. You are in what was the attic space before renovations in 1988. Look up at the bell tower and see the details of the clock face, ornamental ironwork and weather vanes around the deck of the tower. The clock faces are over nine feet across.

Walk around the atrium. On the south side of the fourth floor are the Mayor's and CAO's offices.

We hoped you have enjoyed your tour of this beautiful building.

Please enter the elevator and return to the first floor. In the bookcase, opposite the elevator on the first floor, are several brochures on Belleville and the surrounding area that will inform you of other attractions to see.

★ City of ★

# BELLEVILLE

DESIGNATED SITES

*Walking Tour*



★ City of ★

# BELLEVILLE

## DESIGNATED SITES

### Walking Tour



- |   |  |  |
|---|--|--|
| <p>1. City Hall / Market Square,<br/>169 Front St.<br/>Memorial Arena, 15 Market St.</p> <p>2. 237 Front St. (CIBC)</p> <p>3. 258 Front St.</p> <p>4. 20-24 Victoria Ave.</p> <p>5. Henderson Building, 399 Front St.</p> <p>6. Meyers Mill, 54 Station St.</p> <p>7. VIA Train Station, 220 Station St.</p> <p>8. St. Michael the Archangel,<br/>296 Church St.</p> <p>9. 25 Alexander St.</p> <p>10. 290 George St.</p> | <p>11. Bellevue Terrace, 10 Patterson St.</p> <p>12. O'Hare-Chant House, 231 John St.</p> <p>13. 227 John St.</p> <p>14. 221 John St.</p> <p>15. 209 John St.</p> <p>16. 21 Queen St.</p> <p>17. 118 Bridge St.</p> <p>18. 193 George St.</p> <p>19. 159-161 George St.</p> <p>20. 173 William St.</p> <p>21. 240 William St.</p> <p>22. 288 William St.</p> | <p>23. Corby Rose Garden, 210 Ann St.</p> <p>24. 191 Charles St. / 197 Charles St.</p> <p>25. Glanmore National Historic Site,<br/>257 Bridge St. E</p> <p>26. 151 Dundas St. E.</p> <p>27. 75 St. Paul St.</p> <p>28. 45 S. Front St.</p> <p>29. 143-145 Pinnacle St.</p> <p>30. 180 Coleman St.</p> <p>31. 6 Willard St.</p> <p>32. 11 Charlotte St.</p> <p>33. 110 Bridge St. W</p> |
|---|--|--|



### 1. City Hall, 169 Front St. (designated 1979)

Built in 1873, this Gothic Revival-style building with red brick walls 18" thick housed the Town Hall and Market. According to tradition the tower was supposed to be much shorter, but the architect's vision prevailed and the 144 foot tower was completed. The main body of the building was originally two and a half stories with a mansard roof and dormers. The building was renovated to its current four and a half stories in 1988.



### 1. Market Square, 169 Front St. (designated 1993)

The Market has played a major role in Belleville's history; the Market Square is a visible reminder of the importance of agriculture to Belleville's growth. After Samuel Wilmot laid out the plan for a village at the mouth of the Moira in the spring of 1816 (on land originally set aside for Mississauga Indians), the government reserved several lots for public purposes. These lots were for a future court house and gaol, hospital, district grammar school, Anglican Church, burying ground and rectory, and a market. Originally located west of the present site, the market soon was relocated south of Dundas Street. By the 1840's most vendors moved to the present site, although fish and wood markets continued elsewhere. In the early 1850's, a substantial, two-storey, brick, public market building was built at the east end of the market square. Several private market buildings stood around the square. Finally, the present City Hall was built in 1872-1873 as a market building and town hall. Town offices occupied the second floor and most of the first floor was an indoor market. There were several exterior doors, most of which were converted later to windows, although it is still possible to see where they were.



### 1. Memorial Arena, 15 Market Street (designated 2003)

The Memorial Arena has played a significant role in Belleville's sports history for over 70 years. It is situated next to the historic Farmers' Market and was built in 1929 in a similar style to the well-known Toronto Maple Leaf Gardens but was modified. This building was purchased by the City in 1946 and was renamed in 1947 "The Memorial Arena" from the "Hume Arena" as a dedication to those who died in the war.



### 2. 237 Front Street | CIBC (designated 1980)

This three storey brick and stone structure was built in 1916 in the classical Victorian Italianate style. The present day structure remains very similar to the original one, with the exception that the awnings have been removed from the windows. In 1930 and again in 1944 the Bank built additions onto the original structure in the fall of 1978. The interior renovations were started and completed in the spring of 1979.

### 3. 258 Front Street (designated 1983)

The original stone building dates from approximately 1824; this foundation still exists. A third storey was added about 1883. The present brick facade was probably added in 1891. This building was originally used as a bakery; in the basement are the remains of a large open hearth. The building retains its original tin ceiling and wood ceiling at the store level.



### 4. Seldon/Asselstine House, 20-24 Victoria Ave. (designated 1985)

20 Victoria: Built in 1836, the building has a cut limestone facade with a balanced arrangement of window and door openings with straight headed brick voussoirs. Rubble stone side walls rise to parapets at the roof, supported by carved stone corbels. Later Victorian owners added a decorative verandah, now gone, and simple brackets with finials, under the eaves. Some early shutter hooks remain. The interior has the original brick and stone fireplace.



24 Victoria: Built in 1879, this brick addition on the east side was used as commercial space by householders in the stone house at 20 Victoria Avenue. Originally, this building was nearly the length of the stone house. The segmental window-heads and the cornice supported by pairs of carved brackets are typical of this period. The second floor has two sash windows and a smaller cornice with the same bracket caps as the first floor.



### 5. Henderson Building, 297 Front Street (designated 2004)

The Henderson Building, a three-storey stone building with brick and iron front that was built in 1859, is a fine example of the Second Empire style of the 1860's and 1870's, so named after Napoleon III's 'Second Empire' in France around that time. The typical characteristics of the period's commercial facades are clearly reflected in the buildings appearance. Important as an early example of using cast iron for window adornments, decorated columns and horizontal bands, the building further embodies the style with its tall narrow casement windows. The hallmark of the style is a high wooden mansard roof, in this case having a convex centre and slightly concave sides which contain ornate dormer windows. This roof was not added until the 1870's, possibly to accommodate an organ and choir loft for the third floor. The iron pillared main floor originally had two shops with central doorways and large shop windows. This is the only complete cast iron main floor remaining in Belleville. The long narrow windows of the second storey have iron pediments. Hood moulds were used on the third storey windows. The wood cornice and brackets are original.





### 6. Meyers Mill, 54 Station Street (designated 1978)

This mill was built around 1792 by Belleville's first founder, John Walden Meyers. It is built of limestone from the Moira River and originally was much larger with additional wings. Meyers was a United Empire Loyalist and a British spy during the American Revolution. After defeat of the British, he migrated north to British territory. Meyers is considered the founder of the community, as he attracted other Loyalist refugee settlers to the area. It was named Meyers' Creek in his honour.



### 7. Railway Station, 220 Station Street (designated 1982)

Belleville has always had a close tie with the Grand Trunk Railway, now a part of the Canadian National Railway system. John Bell of Belleville was the first solicitor of the Grand Trunk Railway and played an important role in shaping the company's policies. During the years of construction, Belleville was a surveying and contracting centre, and in 1855 the town was named an official divisional point, with a small switching yard being laid out. By 1864, about one hundred persons were employed at the shops and yards and the station was described as one of the most profitable on the line. The Grand Trunk operations at Belleville continued to expand, and this centre and Brockville remained the divisional points on the 335 miles of main line from Montreal to Toronto. Later, employment would pass the 1,000 mark and Belleville would become the headquarters of the CNR Rideau District.



### 8. St. Michael the Archangel, 296 Church Street (designated 1989)

This Gothic styled church is built of rusticated stone. The plan of the church is rectangular, excepting a small gabled wing on the north west corner which contains the sacristy, and the chancel wall which is a polygonal apse. The roof is pitched and segmented into the clerestory roof of the nave and the lower aisle roofs. The history of the parish of St. Michael the Archangel dates back to the early pioneer days, when Rev. Alexander MacDonnell came to this district. The congregation grew rapidly, and in 1837 a stone church replaced the former structure. On August 22, 1886, the corner stone was laid by Archbishop Cleary. On December 17, 1904, this church, which was similar in design and architecture to the present St. Michael's Church, burned to the ground. There was little or no insurance carried and financing the building of a new structure seemed impossible, but built on the faith of willing parishioners, a new St. Michael's rose out of the ashes within a year. This new beautiful church was built under the guidance of a remarkable man, Father Twomey. Today, Father Twomey rests under the tower of the church he helped to erect. The present Church of St. Michael the Archangel was opened on October 15, 1905.

### 9. 25 Alexander Street (designated 1984)

The house was built in 1869 by carpenter Thomas McRae and bought by Anson Van Norman in 1874 who expanded and renovated in the Victorian style between 1883 and 1888. Italianate features include a pedimented round-headed windows and doors, a tower-like projection on the east facade, and heavy brackets under the eaves. There is iron cresting over the front bay windows, a balustrade on the porch roof and the original hinged shutters. The exterior has changed little with the exception of the slate roof which was replaced with shingles.



### 10. 290 George Street (designated 1984)

This one and a half storey brick building with an upstairs dormer has a brick sunporch on the south side and a board and batten wing at the rear. The facade is symmetrical with a centred entry and a large window on each side. The interior moulding, the original oak floors and pine doors are still in excellent shape. The house is a fine example of a modest home of the period.



### 11. Bellevue Terrace, 10 Patterson Street (designated 1980)

This building was built in 1876 by local clothier Isaac Graham, an ancestor of the present Graham families of Belleville. Many fine features include the sculptural quoins, the window hoods, the eave brackets and scroll design of the frieze, the elaborately detailed porches, portions of the exterior done in cement (introduced into construction in the 1870's), and the interiors of heavy plaster, with many cornices still remaining. Black and white Italian marble fireplaces also help to make this one of Belleville's most impressive buildings.



### 12. O'Hare-Chant House, 231 John Street (designated 1983)

Built in 1854 by John Jordan, part owner of the Victoria Iron Foundry. It is a five bay, full two storey brick building with a wood shingled roof that is hipped and peaked with a flat part on the top. The roof overhang has boxed wood modillions which are squared off rather than curved and carved. It has the original shutters and wood trim, including the cornice, cast iron window sills and lintels.



### 13. 227 John Street (designated 1992)

This house was built in 1917 and was originally owned by Fredrick Quick. Mr. Quick sold men's clothing at Market Square and later moved his store to 258 Front Street. It's a combination of Old English Cottage, Western Bungalow, Craftsman and Colonial styles.







#### 14. 221 John Street (designated 1992)

Built in 1871, this is a two-storey brick structure with a bay extending through both stories on the south front. It has a stone foundation and off-white brick plinth. There are Gothic-type lintels over the first floor windows and rounded lintels over the second floor windows. The lintels are of off-white brick, since painted, and match the plinth and decorative course surrounding the house at the second floor level. The multiple chimneys are Tudor type with brick bases topped with small string courses. The front porch has a wooden gable roof supported by massive wooden brackets similar to those under the eaves.



#### 15. 209 John Street (designated 1989)

This is a two and a half storey brick structure with a stone foundation and bargeboard decorated gables on all sides. Most of the windows have segmental arches, excepting two rectangular windows on the north side and all of the windows inside the gable which are perfectly arched. The windows are accented with brick and stone arched lintels. The entrance consists of a small white porch with decorative jagged wooden sheathing around a flat roof, supported by four white pillars. Above the entrance is a dormer window protruding from the roof.



#### 16. Bell-Riggs House, 21 Queen Street (designated 1985)

This house was built in 1855. There is an Italiante Tower over the entrance, but it is off-centre to the plan of the whole building. The Italiante is also emphasized in the round headed windows on three sides of the tower, the round headed entrance and west side doorways, and the scrolled brackets eave all around. The original 12 pane windows have flat arches of brick and were originally shuttered. The oriel window over the entrance was a later change. The front and west side verandahs were likely installed in the 1890's with the verandah posts and fretted brackets of the late Victorian fashion. About 1890 a portico was erected over the front entrance, with classical details including a bracketed pediment, and a handsome doorcase with side pilasters and a round arched fanlight of red stained glass.



#### 17. 118 Bridge Street (designated 1984)

This two and a half storey clapboard house on the original stone foundation has a wealth of woodwork details representative of the late Victorian period. It was built in 1895 by Mr. H. Pringle of the Pringle Company, builders that specialized in hardwood interior fittings. This company also furnished building materials for several prominent banks throughout the province. Each facade displays a peaked gable, three of which are outlined with bargeboard of a design typical of the time. The windows have decorative trim, many with shutters and pedimented heads. The portico and porches are finished with elaborate wood detailing.

## 18. 193 George Street (designated 1988)

Built in 1863 by William Davy, this home is of brick construction and consists of a main building facing George Street and an attached section at the rear referred to as a “kitchen”. The wooden brackets under the eaves are simple and slightly curved and lend themselves to the simplicity of the design. The windows are symmetrically placed across the front of the house. The windows are topped with flat arches. Between the kitchen and living room are two Greek columns and another two straddle the fireplace in the living room. The hardwood floors have oak and cherry in them. The newel post has a flowery design carved into it.



## 19. 159-161 George Street (designated 1986)

The wood used to build this house in 1873 contained no knots. Above impressive double doors of carved wood, with wood paneling at sides and top, is a pair of double hung windows. The north side features a projecting two storey bay with a string course above the ground floor windows. On the south side a projecting five window bay on the ground floor has carved wood panelling above the windows. Above this the second storey window has an arched lintel. Lintels and sills on the front are dressed stone. The south side has a gable with wood trim. On the north side, wooden brackets support the hipped roof of the bay. North and south facades are gabled with bargeboards and wood trim with pendants at the peaks. On each side is a four flue chimney. The coach house at the rear is a two storied brick building with a gabled roof.



## 20. 173 William Street (designated 1985)

Built 1851, this brick building is two storeys and has a hipped roof. The facade of the house oriented west, is divided into three bays. On the first floor there is a centred entrance under a trellis verandah that is flanked on each side by one sash window with 2/3 panes and segmental brick arches. On the second floor there are three windows with the same characteristics, except the middle window is set in a square stepped-in arcade. On the facade, marks of an old verandah are still visible. The house has a simple wood cornice supported by wood brackets. The existence of a simple wood frieze can still be seen. In the backyard there is a carriage house with a gable roof. The carriage house is constructed of brick, and is one and a half storeys high. It has two large round-head entrances.



## 21. 240 William Street (designated 1991)

This brick building, built in 1874, is T-shaped, with three bay windows on the main floor. Of special interest is the handsome enclosed winter or storm porch with its long narrow rounded windows which help to enhance the tone of the other plainer windows and the house as a whole.





## 22. 288 William Street (designated 1991)

This house was built for \$1,200 in 1874 for John Ross, owner of a local flour and feed store. Ross established a boarding house there. The house was built of “hollow wall” construction because it was believed to provide better insulation.

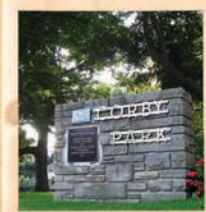

## 23. Corby Rose Garden (designated 2007)

Donated to the City of Belleville in 1905 by Mr. Corby, it is the first public park to be designated. In 1967 it was converted to a rose garden. Corby Rose Garden features display beds of 2,000 roses, perennial and annual flowers and had a new fountain installed in 2013.

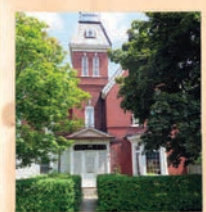

## 24. 197 Charles Street (designated 1989)

Built between the years of 1872 and 1873, this house is a mixture of various architectural styles, such as Italianate, Victorian, Second Empire and Gothic. It has a mansard roof with small Gothic windows, cast iron crestings, gables and tall paired chimneys.



## 25. 191 Charles Street (designated 1989)

This house was built in 1872 as a manse for Bridge Street Methodist Church. It is a good example of a Victorian family home. The facade has the door on one side and two tall windows. The upper floor has two tall windows with a false one in the center. Cornice brackets extend around the main section of the house but are not found on the lower rear wing. The side porch has been restored to be similar to the original. Much of the interior woodwork remains, including the original stairs, fir floors, period baseboards and some wainscoting.



## 26. Glanmore National Historic Site, 257 Bridge Street East

(designated 1985)

Glanmore was completed in 1883 for John Philpot Curran Phillips. The building was designed by Thomas Hanley, a Belleville architect who was born in Read. This impressive yellow brick house reflects the architectural style of the eclectic Second Empire. It features an irregular shape, with bay windows and projections; iron cresting outlining the main roof; a coloured, fish-scale pattern of slates on the concave mansard roof; wide eaves supported on carved brackets, and the original wooden eavestroughs.

Stone trimmed windows and doorways have semi-circular and elliptical heads, and wood trim ornaments the semi circular heads of the dormers windows. The interior is outstanding in that it retains an unusually complete amount of the original detailing of a highly ornate Victorian style. Important are the elaborate and detailed woodwork, cornices, painted ceilings, window and door treatments, fireplaces and overmantle.

In 1971, Glanmore was bought by the City of Belleville and the County of Hastings for a museum. After certain structural restorations, it opened to the public in July 1973.





### 27. Kinsmen Park, 151 Dundas Street (designated 1991)

The Dundas Street East burying ground was consecrated on March 3, 1828 as one of Belleville's first cemeteries. Old surveys and registered land plans show a lot marked "WM burying grounds", presumably meaning Wesleyan Methodist. In 1872 when the Belleville Cemetery on Dundas Street West was opened, it is speculated that bodies could have been transferred there and the cemetery ritually closed by the Wesleyan Methodist congregation. Belleville Cemetery did not keep precise records prior to 1895, therefore there are no records of any such transfers, leaving the only way to tell by identifying names on aged gravestones. In 1916 the land was sold to Francis and Mary O'Flynn by the City for tax arrears by the owner of the ground. The O'Flynn's in turn sold the land back to the City in 1925 to preserve the property for use as a public park or "open breathing space". In the early 1950's the land was leased to the Kinsmen Club who have established and maintained the site as a children's playground until this day. However, it is presumed that many of our earliest settlers are buried there.

### 28. Foster Ward Community Centre, 75 St. Paul Street

(designated 1985)

Built in 1899 by Abbott, Mitchell Steel & Iron Company, this building has distinctive polychromatic brickwork, quoining, a bell-shaped roof and interior wood casing and trim. The north side of the building presents the facade with centred a main door and with one large sash window on each side. The second floor has three large sash windows. All the windows and doors present the same characteristic wood sills and yellow coloured brick voussoir arches above the plinth of the building which is made out of large pieces of stone.



### 29. McIntosh-Ridley House 45-47 South Front Street

(designated 1983)

Dating from 1817, this early building is of post and beam construction. To the big square timbers of the frame, clapboard was nailed on the outside and hand split lath on the inside. The space between was filled with bricks and mortar. The fireplace, with its bake oven, is still in place in the kitchen wing at the back. The house is the keystone of at least a dozen early buildings still existing from the harbour front settlement.



### 30. Liddle Tailor Shop 143-145 Pinnacle Street (designated 1991)

Built in 1850, this two storey double town house is of rubble stone with a brick facade facing Pinnacle Street. The stone is reputed to be 2 feet thick on the end walls and the brick 3-bricks thick on the front wall. It has a parapet gabled roof with centered chimneys on north and south end walls. The roof was wooden, probably hand-made pine on cedar shingles. There are six windows facing Pinnacle Street on the second storey with 6 over 6 framing. There were 4 identical windows on the first floor facing Pinnacle Street. Hand cut stone flat arch style lintels are found above and below each window in both storeys. The roosters carved above the doors indicate that the building may have been used as a customs house.



### 31. Billa Flint House, 180 Coleman Street (designated 1990)

Built for Billa Flint in 1835, this two storey brick house that has a three bay facade with the entrance in the left-hand bay. The front doorway opening was obviously wide enough for side lights but the sides have been narrowed with modern brick. Investigation inside shows that these side spaces were blind; perhaps occupied by panelling or more likely by half-columns. The roof shows four thick places in the parapet ends, like the bases of chimneys, but no trace of flues is visible in the rooms. All four have been reconstructed to restore the house's skyline. Window glazing, 12 over 12, appears to be the original in the three upper front windows and at lower right. Old maps show at least two different kitchen wings on the back in different configurations. There was only one opening on the south side of the main block originally. Flint was a general merchant in Belleville in 1829, and also established a large lumbering business at the mouth of the Moira River. Flint was President of the Belleville Police Board in 1836, Mayor of Belleville for three years, and Warden of Hastings County in 1873. From 1847 until his death in 1894 he represented the area in the Canadian government, becoming a Senator in 1867.



### 32. 6 Willard Street (designated 1985)

Built in 1849, this single storied house had a central doorway and one large window on each side. The facade features stone lintels, bush hammered with a chiseled margin, over the door and windows. The window sills are also bush hammered. Below the hipped roof is a dentil-like row of rowlocks, alternately projecting and flush with the brick walls. Wooden brackets under the eaves have been restored. The off-centre stone kitchen at the rear was probably built at the same time as the brick portion. It features a cooking fireplace at the west end. Walls and ceiling of this wing are wood panelling with a chair rail.





### 33. 11 Charlotte Street (designated 1990)

This one and a half storey home was built in 1857 for Archibald Ponton and rented to businessman George Ritchie until 1874 when Mr. Ponton moved into the home with his family of 10. The house appears to be of post and beam construction. It is brick lined and covered with two inches of plaster, with an outside covering of clapboard. The front door which faced east appeared to have once been a double door which was later fastened together to form a single unit. The side lights have a panel at the bottom with a long window above with mullions dividing panes that are half the size of the outside edge. Above is a transom light divided in three sections. Inside, the hall is very wide. It has fairly plain wood work and a narrow bannister with a hook-like projection over slender newell posts. Balustrades are straight narrow pieces which very easily slope to the stairs. The rooms are large as are the windows which have wood panels beneath them. There is a fireplace in the center of the north wall of the main floor. It has wide fluted pilasters, topped by corner boxes and decorated with a carved rose. There is one original window still in place within the south wall. It has half panes along the side. Some of the early windows have been used in the enclosed west porch. In 1873 the roof was raised to make it a two storey home.



### 34. 110 Bridge Street West (designated 1986)

Built in 1867 by Smith Steven, a clerk in the Grand Trunk Railway solicitor's office, it is an excellent example of a family home owner of modest means, with original 6/6 pane windows, window sills, and shutters. Acorn brackets extend under the cornice. The front door, balanced by narrow sidelights, has a false centre bead forming a mid-line, a feature which is a rarity in Belleville.



★ *City of* ★

# BELLEVILLE

== PLACES OF WORSHIP ==

*Walking Tour*

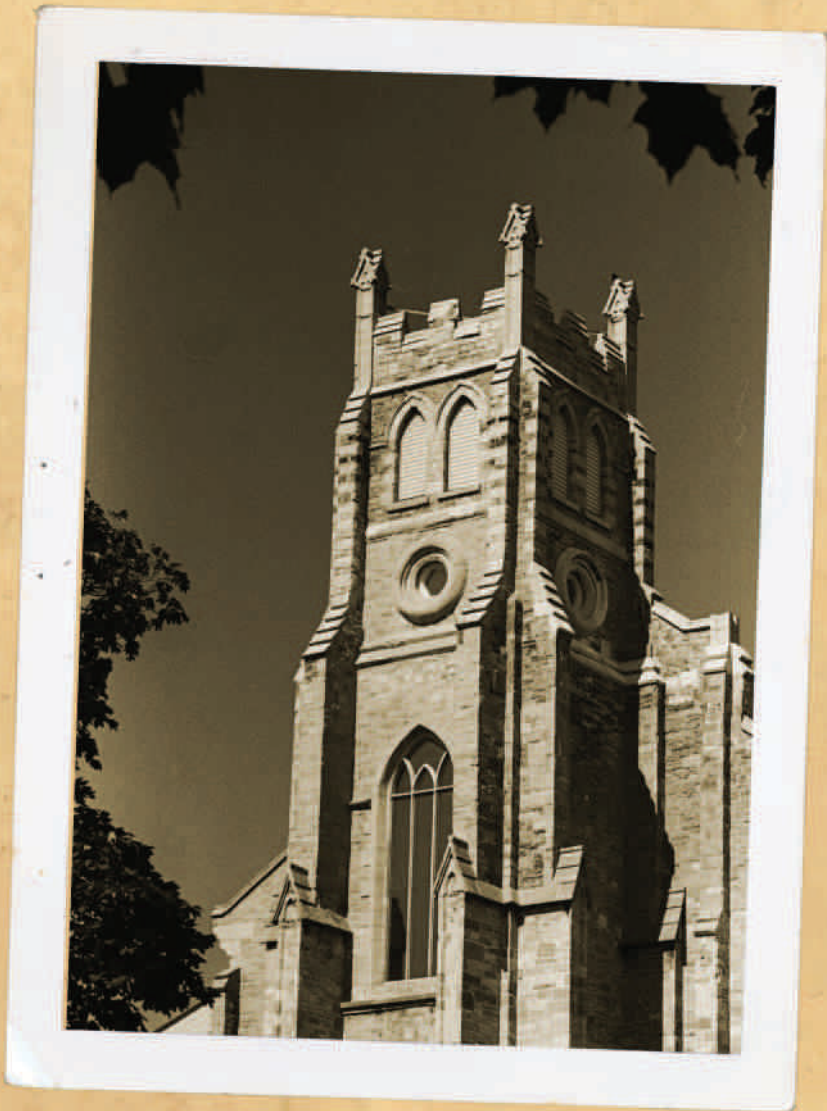



★ City of ★  
**BELLEVILLE**  
 PLACES OF WORSHIP  
*Walking Tour*



- |  |   |
|--|---|
| <ol style="list-style-type: none"> <li>1. 132 Pinnacle St.</li> <li>2. St. Paul's Anglican Church, 35 St. Paul St.</li> <li>3. St. Thomas' Anglican Church, 201 Church St.</li> <li>4. Bridge Street United/Methodist Church, 60 Bridge St.</li> <li>5. Salvation Army Citadel, 256 Pinnacle St.<br/>(now Pinnacle Playhouse)</li> <li>6. Victoria Ave. Baptist Church, 34 Victoria Ave.</li> <li>7. 54 Victoria Ave.</li> <li>8. St. Andrew's Presbyterian Church, 67 Victoria Ave.</li> <li>9. Northeast corner of John St. and Victoria Ave.</li> <li>10. 305 Church St.</li> </ol> | <ol style="list-style-type: none"> <li>11. St. Michael's Catholic Church, 296 Church St.</li> <li>12. 329 Church St.</li> <li>13. Bethel Chapel, 333 Church St.</li> <li>14. 170 Station St.</li> <li>15. 193 Lingham St.</li> <li>16. 7 Cameron St.</li> <li>17. 16-18 North Front St.</li> <li>18. 33 Moira St. W.</li> <li>19. St. Matthew's United Church, 25 Holloway St.</li> <li>20. 50 Bridge St. W.</li> <li>21. Christ Church Anglican, 39 Everett St.</li> </ol> |
|--|---|

This tour takes a look at the many buildings and sites in Belleville that existed from the City's beginning up to 1940 that served a religious purpose, some of which continue to do so. It is designed with City Hall as the starting point, and the approximate walking time is 2 hours.

### 1. 132 Pinnacle Street

This was the site of the first church in Belleville, built in 1818 by the Methodist congregation. It was replaced in the 1830's by a frame structure and then replaced again by a much larger brick building in the late 1830s early 1840s. In 1870, it was deconsecrated and sold to the Free Masons who owned it until 1873 when it was sold to the Grand Trunk Railway. It was demolished in August of 1970.

### 2. St. Paul's Anglican Church, 35 St. Paul St.

Between 1874 and 1880 this building was erected by Rev J.W. Burke, rector of St. Thomas' church. It was originally a mission for the poor and the people arriving by boat in Belleville including the sailors. White stucco was applied to the exterior in the 1920's.



### 3. St. Thomas' Anglican Church, 201 Church St.

The St. Thomas congregation was formed in 1818 and the first church was built on this site in 1819-21. The congregation outgrew this church and it was replaced by a stone church in 1858. This church burned to the ground in 1876. It was reconstructed and opened in 1879. The church was again destroyed by fire in 1975, but was quickly restored and reopened in 1976.



### 4. Bridge Street United/Methodist Church, 60 Bridge St.

This church was built in 1887, after the original sanctuary, which opened in 1865 on this site, was destroyed by fire. The church is a large stone building with a tower in the centre of the façade facing east, and stained glass windows. It is an example of an eclectic Gothic or Romanesque style. The church still has the foundation and the tower of the 1865 structure. The original building hosted the conference which laid the foundation for the union of most Canadian Methodist Churches.



### 5. Salvation Army Citadel, 256 Pinnacle St. (now Pinnacle Playhouse)

The Salvation Army came to Belleville in 1884. The first meetings were held in the Metropolitan Hall which was located where the Royal Bank of Canada now stands on Front Street. This building was built in 1940 to house the growing numbers. The central opening now used as a display window, was the original entrance. In 1969, a new facility was built on Victoria Ave. The Salvation Army Church is presently located on Bridge Street West.





## 6. Victoria Avenue Baptist Church, 34 Victoria Ave.

Belleville's first Baptist congregation began meeting in parishioners homes in the early 1870's. In 1873, they began to use the Court House for Sunday services. By 1875, a church on the corner of Coleman and Moira Streets had been dedicated. The congregation outgrew this building and in 1896 moved to a building which had once been a roller skating rink on the corner of Victoria Ave and Pinnacle St. By 1906 the present church was opened on that site.



## 7. 54 Victoria Avenue

A small building resembling a church was located here as it appears on the 1874 map of Belleville. It was listed as the Congregational Church. It was most likely removed sometime before the turn of the century.



## 8. St. Andrew's Presbyterian Church, 67 Victoria Ave.

In 1821, the government granted one acre of land to the Church of Scotland. The first church on this site was built in 1831. It was made of wood and in 1870-72 was replaced by a brick building which burned in 1894. The present structure was erected in 1895 on the foundations of the second church. The building has a large tower, spire and Tiffany window.



## 9. Northeast corner of John St. and Victoria Ave

This north east corner was once the site of John Street United/ Presbyterian Church. It was constructed in 1852 in the Gothic Style, and was said to seat 500. It was built for the Free Presbyterian Church, which was under the leadership of Reverend William Gregg. An organ was donated in 1929 by R.J. Graham, a wealthy citizen, which led to some alterations and improvements to the church. The church burned down in October of 1936, and it was decided that it would not be rebuilt. The congregation merged with other city churches.



## 10. 305 Church Street

When the Tabernacle Church outgrew its facilities at 329 Church St. in 1877, a new church was built here in 1878. This building was demolished in 1996 when it was closed and purchased by the separate school board. The congregation amalgamated with that of Holloway St. United Church to form St. Matthew's United Church.

## 11. St. Michael The Archangel, 296 Church St.

This Roman Catholic Church is built in a Gothic style of rusticated stone. The first church was built on this site in 1829 and was a small wooden structure. It was replaced by a stone church in 1837. A larger church was built on the site in 1885. It burned down in 1904, and was rebuilt to a similar design in 1905, under the leadership of Father Twomey who rests now beneath the tower. The 1905 structure is the structure used presently. This building was designated under the Ontario Heritage Act in 1989



## 12. 329 Church Street

The Methodist Episcopal congregation of Belleville built a chapel on this site in 1845. In 1865, the chapel was enlarged to seat 300, and believe it or not, the present building at this address is the 1865 Tabernacle Church. Although buried under many years of remodeling, the original building is still there. When the congregation outgrew this building they built Tabernacle Church at 305 Church St.

## 13. Bethel Chapel, 333 Church St

This building was constructed around 1929 for an undenominational congregation of Christians. This group's first recorded meeting was in 1883 at the Metropolitan Hall where between 300 and 400 people attended.

## 14. 170 Station Street

At this address, now where Cannifton Rd. meets Station St., there once stood a small building used as a church. It is marked on an 1874 map as a Roman Catholic Church, and a reference is made to a St. George's on Station St. Not much is known about this building. It was demolished sometime in the late 1970's.

## 15. 193 Lingham Street

This house sits on parts of the original foundation of the Bleeker Street Wesleyan Methodist Church. Tobias Bleeker owned this land originally and when he died, he left provisions in his will for land for a church. The first church opened on Sun. Oct 2, 1859. It was destroyed by fire in 1865 and was rebuilt two years later. It was again destroyed in 1880, but again was rebuilt. The church appeared in the religious directory of Belleville until 1918.

## 16. 7 Cameron Street

This unique looking building was not originally built here as a church. Originally there was a frame house and shed at this location. In 1911, there was a fire that destroyed the house and shed and the present structure was assembled on the site by Mr. Aselstine who ran a stage coach line in the city. The supplies used to build the structure came from a country church which helps explain its unique characteristics.



## 17. 16-18 North Front Street

This building was originally the Bible Christian Church built in 1872. The first minister was Rev. John Gordon. The church closed in 1888.



## 18. 33 Moira Street West

The congregation that originally used this building began in 1922 at a mission on Dundas Street. This building was built in 1930 to accommodate the growing numbers of the Quinte Christian Alliance Church. This building also became too small and the congregation moved in 1982 to Bridge Street West.

## 19. St. Matthew's United Church, 25 Holloway St.

The St. Matthew's congregation came into existence with the amalgamation of Holloway Street United Church and Tabernacle United Church in 1996. The Holloway congregation began in 1874, in a small frame structure built as an extension of Bridge Street Methodist Church. The corner stone of the present structure was laid in 1876, and the church was originally known as the West Belleville Methodist Church.



## 20. 50 Bridge Street West

This site was formerly occupied by St. John's Anglican Church which existed here from the 1880s until 1912. The church was originally built in 1875 and was located near Bridge Street West and Sydney Street, but was moved to this location later on. It was later absorbed by Christ Church parish and it was then determined that the building could be of use to the Point Anne community. It was moved in what is to be believed its entirety down the frozen bay to its new location, where it remained until 1973.

## 21. Christ Church Anglican, 39 Everett St.

The Christ Church congregation split from St. Thomas' Church in 1863. In 1865 a church was built on West Moira St. almost directly across from 33 Moira St., next door to the present funeral home. This church on Moira St. burned down in 1881, and the present structure at Coleman and Catherine Streets was constructed. Inside the church is a piece of marble which is embedded with mementoes from shrines and tiles from ancient Celtic Churches in Great Britain.

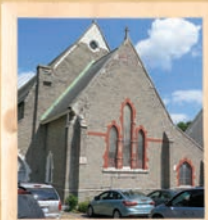

★ City of ★  
**BELLEVILLE**  
== HISTORICAL PLAQUES ==

### **Albert Carman 1833-1917**

A commanding figure in Canadian Methodism during the late 19th and early 20th centuries, Carman was born in Iroquois and educated at Victoria College, Cobourg. He worked briefly as a teacher and was then appointed principal of Belleville Seminary, later Albert College, in 1858. A masterful administrator and, after entering the Methodist Episcopal ministry, a militant advocate for Methodist education, Carman spearheaded the successful development of this Methodist school during his 17-year term there. Following his election as a Bishop in 1874, he gained increasing prominence in church affairs, particularly as an ardent supporter of union among the Methodist denominations. When union was achieved in 1884, Carman became a General Superintendent of the Methodist Church, a post he held until his retirement in 1914.

Plaque Location: On the east side of Church Street north of Victoria Street, just north of Nicholson Catholic College.

### **Albert College**

In 1854 the Methodist Episcopal Church, recognizing the need to improve the training of its clergy, began the construction of a seminary on this site. Designed to accommodate 150 residents with classroom facilities for 400 students, Belleville Seminary was opened in July 1857. Under the able direction of its principal, Albert Carman, the school flourished, producing several eminent graduates. In 1866 it was rechartered as Albert College, an affiliate of the

University of Toronto, and five years later it became an independent degree-granting institution. When Victoria College in Cobourg was chosen as official university for the newly-formed Methodist Church in 1884, Albert College became a private collegiate. Moved in 1926 to the present location overlooking the Bay of Quinte, it remains a distinguished residential school. Plaque Location: On the west side of North Park Street midway between College Street East and Donald Street.

### **Belleville**

By 1790 the mill, tavern and stores established here near the Bay of Quinte had stimulated the growth of a settlement. Named "Belleville" in 1816, the village progressed steadily as a milling and shipping centre, and in 1834 the thriving community became a police village. The completion in 1856 of the Grand Trunk Railway between Toronto and Montreal, a booming lumber trade, and the development of a fertile agricultural hinterland fostered significant commercial and industrial growth in Belleville, which had become a town in 1850. Following the discovery of gold near Madoc in 1866, Belleville was known as the "golden gate" of Hastings County, and after 1872 became a major Canadian marketing centre for cheese. In 1877 it was incorporated as a city.

Plaque Location: On the east side of the park road in Victoria Park, west off South Front Street just south of Dundas Street.



## Belleville City Hall

This imposing structure was erected in 1872-73 to house the public market and administrative offices of the rapidly expanding municipality of Belleville. It was designed by John Evans, a local architect, and constructed by contractor, John Forin. A fine example of High Victorian architecture, the handsome brick and limestone structure was built as an expression of civic pride and confidence in the future. It is distinguished by tall, arched windows on the second floor, a bell-cast mansard roof with dormers and a massive clock tower strengthened by octagonal buttresses. Aside from its administrative function, the structure has also served as a meeting place for religious, social and commercial organizations. Little altered since erected, it continues today to be the most prominent landmark within the community.

Plaque Location: On the east side of Front Street between McAnnany Street and Market Street, a block north of Dundas Street.

## Captain John W. Meyers 1745-1821

Meyers gained fame as a loyalist spy during the American Revolution. He recruited soldiers, gathered intelligence, and carried dispatches through enemy lines for the British army in his native New York. Exploits such as his daring attempt to capture rebel General Philip Schuyler in 1781 made "Hans Waltermeyer" a legendary figure in the folklore of the times. After the war, Meyers moved north to British territory and bought this site for a grist mill in 1789. He traded furs, ran merchant vessels, and built a sawmill, distillery, fulling mill, and inn nearby. The surrounding community became the town of Belleville in 1816.

Meyers was one of many loyalists whose defeat in war led to the beginnings of permanent settlement in what is now Ontario. Plaque Location: On the north side of Station Street (Road 37) across from Dafoe Street, two blocks east of Pinnacle Street.

## Formation of the Methodist Church 1884

The largest Protestant denomination in Canada during the late 19th and early 20th centuries, the Methodist Church (Canada, Newfoundland, Bermuda) was established in 1884. Its formation marked the culmination of a long series of mergers between groups of British and American origin. The first broad union occurred in 1874 when three denominations, amalgamations of smaller groups, joined to form the Methodist Church of Canada. Nine years later, at meetings held in Belleville, union of all mainline Methodists was proposed. After intense debate, delegates representing the Methodist Episcopal Church in Canada, the Bible Christian Church of Canada, the Primitive Methodist Church in Canada and the Methodist Church of Canada approved the merger and on July 1, 1884 the Methodist Church (Canada, Newfoundland, Bermuda) was officially established.

Plaque Location: In front of the church on the northwest corner of Bridge Street East and Church Street

## Glanmore National Historic Site

This imposing house is a fine example of the Second Empire style which was popular in Canada in the 1870s and 1880s. Local architect Thomas Hanley skillfully blended the characteristic Second Empire mansard roof and its ornate dormer windows with asymmetrical massing, a bracketed cornice and iron cresting to create an image of picturesque elegance. The profusion of ornate woodwork and decoration inside the house complement its stately exterior. Built in 1882-1883 for the wealthy banker and financier, J.P.C. Phillips, Glanmore reflects the tastes of the well-to-do in late 19th-century Canada.

Plaque Location: At 257 Bridge Street East, on the southeast corner of Dufferin Street

## Grand Trunk Railway Belleville

The Grand Trunk was incorporated in 1853 to run from Sarnia to Portland, Maine. Although it took over existing lines, new ones had to be built, including sections of the key Toronto to Montréal line completed by the noted English engineering firm of Peto, Brassey, Jackson and Betts in 1856. The Belleville station, built about 1856, is representative of the larger stations erected by this firm for the Grand Trunk Railway. Although its design was influenced by English railway stations, it is an enduring monument to early Canadian railway enterprise.

Plaque Location: Attached to the front wall of the historic railway station at 220 Station Street

## James Bertram Collip 1892-1965

A co-discoverer of insulin, J.B. (Bert) Collip was one of Canada's most prolific medical researchers in the first half of the 20th century. Born and raised in Belleville, Collip received a PhD in biochemistry from the University of Toronto in 1916. There, on leave from the University of Alberta in 1921, Professor J.J.R. Macleod invited him to work with Frederick Banting and Charles Best on a substance they hoped could treat diabetes. In 1922, Collip produced the first insulin suitable for use on human beings, an essential contribution to a treatment that has since saved millions of lives. In 1923, Collip received from Macleod a share of the Nobel Prize money awarded to Banting and Macleod for the discovery of insulin. In Alberta and then at McGill University, Collip became internationally known for his leadership in endocrinology. From 1941 to 1945, he headed Canada's wartime medical research. He finished his career as Dean of Medicine at the University of Western Ontario (1947-61), and died in London, Ontario in 1965.

Plaque Location: In front of the Belleville Public Library at the corner of Pinnacle Street and Campbell Street





## The Ontario School for the Deaf

In 1869, at the urging of John B. McGann, a pioneer educator of the hearing impaired, the Ontario government sanctioned the establishment of the first provincial school for deaf children. A residential institution combining elementary school instruction with vocational training, the Ontario Institution for the Education of the Deaf and Dumb was officially opened in October 1870. Increasing enrolment during the following decades led to steady expansion and improvement of facilities. When curricula were revised and advanced academic instruction introduced during the tenure of Dr. Charles B. Coughlin (1906-28), the school gained wide recognition for its contributions to special education. Renamed the Ontario School for the Deaf in 1913, it became the Sir James Whitney School in 1974 in honour of Ontario's sixth prime minister.

Plaque Location: In front of the main building of the Sir James Whitney School for the Deaf on the northwest corner of Dundas Street West and Palmer Road, entrance off Dundas Street West

## Samuel Thomas Greene 1843-1890

Samuel Greene was the first deaf teacher to teach deaf children in the Ontario school system. An American by birth, he was educated at the National Deaf-Mute College, now Gallaudet University, in Washington, D. C. After graduating in 1870, he came to teach at the new provincial school for the deaf in Belleville (later Sir James Whitney School). Believing that the education of deaf children should be based on solid language skills, Greene devised a progressive and highly successful method of teaching that used sign language and written English. Co-founder and first president of the Ontario Association of the Deaf, he was renowned for his eloquent public addresses and poetry recitations in sign language. Plaque Location: In front of the main building of the Sir James Whitney School for the Deaf on the northwest corner of Dundas Street West and Palmer Road, entrance off Dundas Street West

## Sir Mackenzie Bowell, K.C.M.G. 1823-1917

The fifth Prime Minister of Canada, Bowell was born in Suffolk, England and came to Belleville with his parents in 1833. Apprenticed as a printer at the *Intelligencer*, he advanced quickly, becoming the newspaper's editor and proprietor by 1850. Bowell also gained prominence in the Orange Order, a formidable political force in 19th century Canada, and was elected to the first Dominion Parliament in 1867 as Conservative member for North Hastings. During a long and distinguished public career in which he represented this area for 25 years, Bowell held various ministerial posts. Following the sudden death of Sir John Thompson, he served as Prime Minister (1894-1896). Knighted in 1895, Bowell devoted his final years to journalistic and business activities in Belleville.

Plaque Location: At 194 William Street, on the west side 2nd building south of Bridge Street

## Sir Mackenzie Bowell 1823-1917

Born in England, this printer and publisher represented North Hastings in Parliament from 1867 to 1892, and thereafter held a seat in the Senate until 1917. He served in the cabinets of Macdonald, Abbott, and Thompson, and became Prime Minister in 1894. Past Grand Master of the Orange Lodge in British North America, he nevertheless proposed to the House of Commons in 1896, remedial action that would settle the Manitoba Schools Question. In that same year, division within his cabinet and disenchantment with his leadership forced his resignation. He died in Belleville.

Plaque Location: On the face of a cairn in a small parkette on the southwest corner of St. Paul and Pinnacle streets

## Susanna Moodie 1803-1885

Born in England, Mrs. Moodie immigrated to Upper Canada with her husband in 1832. They farmed near Cobourg for two years then moved to the wooded Rice Lake area near the frontier of the colony before



settling in the more urban environment of Belleville in 1840. Member of a noted literary family, she became a leading author of the pre-Confederation period and her poems and short stories appeared in journals in Canada and England. Her two autobiographical books, *Roughing it in the Bush* (1852) and *Life in the Clearings* (1853), have become Canadian classics.

Plaque Location: In front of Susanna Moodie Cottage, 114 Bridge Street West at Sinclair Street

## William Canniff 1830-1910

Born at Thurlow, Upper Canada, and educated in medicine, Canniff served as Medical Officer with the Royal Artillery during the Crimean War. Returning to practice in Belleville and Toronto, he became professor at the University of Victoria College, sub-dean of the Toronto Medical School, and later Toronto's first Medical Health Officer (1883-91). A member of the Canada First Movement, he was deeply interested in the promotion of colonization of the North West. His writings include contributions to medical literature as well as the useful *History of the Early Settlement of Upper Canada*. He died at Belleville.

Plaque Location: On the front wall of the Hastings Heritage Centre at 154 Cannifton Road North, north of Highway 401 in the Hamlet of Cannifton





== BELLEVILLE.CA ==