

Wilson Avenue Development

City of Belleville

Traffic Impact Study for ROMPSEN

Type of Document:
Final Report

Project Number:
JDE – 21063

Date Submitted:
June 13th, 2022



John Northcote, P.Eng.
Professional License #: 100124071



ENGINEERING

JD Northcote Engineering Inc.
86 Cumberland Street
Barrie, ON
705.725.4035
www.JDEngineering.ca

Legal Notification

This report was prepared by **JD Northcote Engineering Inc.** for the account of **ROMPSEN**.

Any use which a third party makes of this report, or any reliance on or decisions to be made based on it, are the responsibility of such third parties. **JD Northcote Engineering Inc.** accepts no responsibility for damages, if any, suffered by any third party as a result of decisions made or actions based on this project.

Executive Summary

This report summarizes the traffic impact study prepared for the proposed residential development located between Palmer Road and Sydney Street, south of Moira Street, in the City of Belleville [City]. The report assesses the impact of traffic related to the development on the adjacent roadway and provides recommendations to accommodate this traffic in a safe and efficient manner.

The proposed development consists of 86 single detached units and 71 townhouse units.

Access to the development will be provided via extension of Wilson Avenue between Palmer Road and Sydney Street.

The scope of this analysis includes a review of the following intersections:

- Wilson Avenue Extension / Palmer Road & Bogart Crescent;
- Wilson Avenue / Sydney Street;
- Elgin Street / Moira Street West; and
- Tripp Avenue / Moira Street West.

Conclusions

1. The proposed development is expected to generate a total of 110 AM and 137 PM peak hour trips.
2. Detailed intersection counts were conducted at the study intersections.
3. An intersection operation analysis was completed at the study area intersections, using the existing and background (2029 and 2034) traffic volumes, with consideration for the projected adjacent development traffic growth and without the proposed development traffic. This enabled a review of existing and future traffic deficiencies that would be present without the influence of the proposed development. No improvements are recommended within the study area.
4. An estimate of the amount of traffic that would be generated by the Subject Site was prepared and assigned to the study area streets and intersections.
5. An intersection operation analysis was completed under total (2029 and 2034) traffic volumes with the proposed development operational at the study area intersections. No improvements recommended within the study area.
6. The proposed Wilson Avenue extension will operate efficiently as a four-legged intersection, with one-way stop control for eastbound and westbound egress movements. A single lane for ingress and egress movements will provide the necessary capacity to convey the traffic volume generated by the proposed development.
7. The location of the Wilson Avenue extension is considered appropriate with respect to minimum corner clearance and spacing requirements as identified in the Transportation Association of Canada Design Guide for Canadian Roads (2017).
8. In summary, the proposed development will not cause any operational issues and will not add significant delay or congestion to the local roadway network.

Table of Contents

1	Introduction.....	6
1.1	Background.....	6
1.2	Study Area	6
1.3	Study Scope and Objectives	7
1.4	Horizon Year and Analysis Periods	8
2	Information Gathering.....	8
2.1	Street and Intersection Characteristics	8
2.2	Local Transportation Infrastructure Improvements.....	9
2.3	Transit Access	9
2.4	Development Growth.....	10
	2.4.1 Sandy Cherry Court Subdivision	11
	2.4.2 Fairgrounds Property.....	12
	2.4.3 Ben Bleecker Lands	12
	2.4.4 Mancuso Subdivision.....	13
2.5	Background Traffic Growth.....	13
	2.5.1 Population & Employment Growth	13
	2.5.2 Other Studies.....	13
	2.5.3 Overall Background Growth Rate.....	13
2.6	Traffic Counts	13
2.7	Existing Traffic Volumes	14
2.8	Horizon Year Traffic Volumes.....	14
3	Intersection Operation without Proposed Development.....	15
3.1	Introduction	15
3.2	Existing Intersection Operation.....	16
3.3	Background (2029) Intersection Operation	17
3.4	Background (2034) Intersection Operation	18
4	Proposed Development Traffic Generation and Assignment.....	19
4.1	Traffic Generation	19
4.2	Traffic Assignment.....	20
4.3	Total Horizon Year Traffic Volumes with the Proposed Development	21
5	Intersection Operation with Proposed Development	21
5.1	Total (2029) Intersection Operation.....	21

5.2	Total (2034) Intersection Operation.....	23
5.3	Site Access & Intersection Spacing.....	24
5.4	Sight Distance Review.....	25
6	Summary	25

List of Tables

Table 1 – Estimated Traffic Generation – Adjacent Development (Sandy Cherry Court Subdivision)	12
Table 2 – Traffic Count Data	14
Table 3 – Level of Service Criteria for Intersections.....	16
Table 4 – Existing (2022) LOS	17
Table 5 – Background (2029) LOS.....	18
Table 6 – Background (2034) LOS.....	19
Table 7 – Estimated Traffic Generation of Proposed Development.....	20
Table 8 – Estimated Traffic Generation of Proposed Development.....	20
Table 9 – Proposed Development Traffic Distribution.....	21
Table 10 – Total (2029) LOS	22
Table 11 – Total (2029) Left Turn Analysis Summary	22
Table 12 – Total (2034) LOS	23
Table 13 – Total (2034) Left Turn Analysis Summary.....	24

List of Figures

Figure 1 – Proposed Site Location and Study Area	7
Figure 2 – Existing (2022) Intersection Spacing and Lane Configuration with in Study Area.....	9
Figure 3 – Adjacent Development Location	11
Figure 4 – Adjacent Development Traffic Volumes – Sandy Cherry Court Subdivision	27
Figure 5 – Adjacent Development Traffic Volumes – Fairgrounds Property	28
Figure 6 – Adjacent Development Traffic Volumes – Ben Bleeker Lands	29
Figure 7 – Existing (2022) Traffic Volumes	30
Figure 8 – Background (2029) Traffic Volumes.....	31
Figure 9 – Background (2034) Traffic Volumes.....	32
Figure 10 – Site Traffic Assignment	33
Figure 11 – Total (2029) Traffic Volumes.....	34
Figure 12 – Total (2034) Traffic Volumes.....	35

List of Appendices

APPENDIX A – Draft Plan of Subdivision
APPENDIX B – Adjacent Development Excerpts
APPENDIX C – Traffic Count Data
APPENDIX D – Synchro Analysis Output – Existing Traffic Volumes
APPENDIX E – Synchro Analysis Output – Background Traffic Volumes
APPENDIX F – Synchro Analysis Output – Total Traffic Volumes
APPENDIX G – MTO Left Turn Analysis
APPENDIX H – OTM Signal Justification Sheets

1 Introduction

1.1 Background

On behalf of the property owner, **ROMPSEN** [Client] is proposing a residential development on a site located between Palmer Road and Sydney Street, south of Moira Street, in the City of Belleville.

The proposed development consists of 82 single detached units and 71 townhouse units. Access to the development will be provided via extension of Wilson Avenue between Palmer Road and Sydney Street.

It is anticipated that ultimate build-out will occur by 2024.

The Client has retained **JD Northcote Engineering Inc.** [JD Engineering] to prepare this traffic impact study in support of the proposed development.

1.2 Study Area

Figure 1 shows the location of the subject site and study area intersections in relation to the surrounding area. The Draft Plan of Subdivision by Innovative Planning Solutions Inc. is provided in **Appendix A**.

The subject site is bound by existing residential lands to the north and east, Dominion Drive to the south and vacant land to the west.

Through consultation with the City, the following intersections are included in the traffic impact study:

- Wilson Avenue Extension / Palmer Road & Bogart Crescent;
- Wilson Avenue / Sydney Street;
- Elgin Street / Moira Street West; and
- Tripp Avenue / Moira Street West.

Figure 1 – Proposed Site Location and Study Area

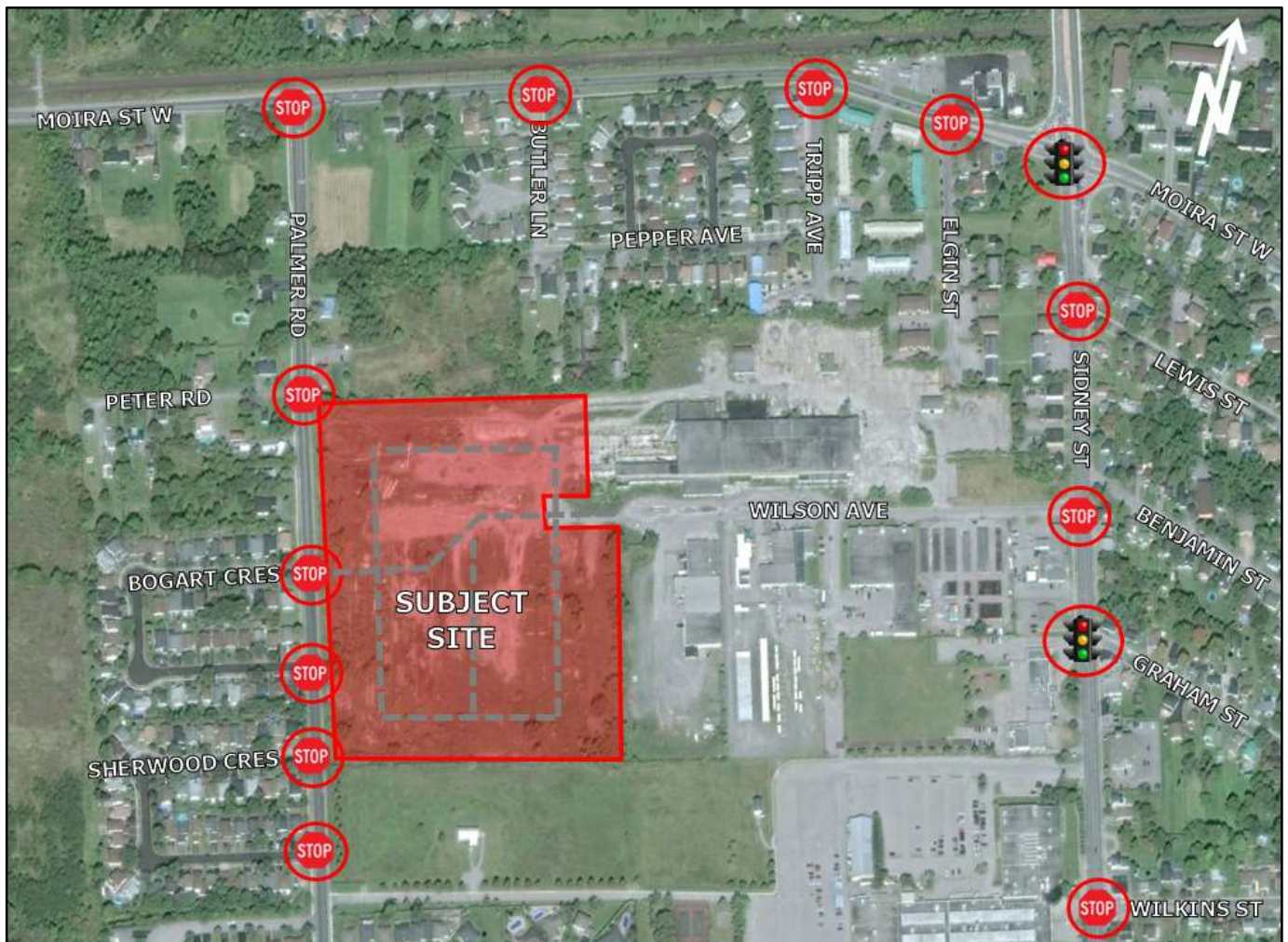

1.3 Study Scope and Objectives

The purpose of this study is to identify the potential impacts to traffic flow at the site accesses and on the surrounding roadway network. The study analysis includes the following tasks:

- Consult with the City to address any traffic-related issues or concerns they have with the proposed development;
- Determine existing traffic volumes and circulation patterns;
- Estimate future traffic volumes if the proposed development was not constructed, including the impact of additional proposed developments in the area;
- Complete level-of-service [LOS] analysis of horizon year (without the proposed development) traffic conditions and identify operational deficiencies;
- Estimate the amount of traffic that would be generated by the proposed development and assign to the roadway network;
- Complete LOS analysis of horizon year (with the proposed development) traffic conditions and identify additional operational deficiencies;

- Identify improvement options to address operational deficiencies;
- Review the proposed intersection spacing;
- Complete a sight distance review for the proposed Wilson Avenue extension; and
- Document findings and recommendations in a final report.

1.4 Horizon Year and Analysis Periods

Traffic scenarios for the existing year, 5-year post-buildout horizon year (2029) and 10-year post-buildout horizon year (2034) were selected for analysis of traffic operations in the study area. The weekday morning [AM] and weekday afternoon [PM] peak hours have been selected as the analysis periods for this study.

2 Information Gathering

2.1 Street and Intersection Characteristics

Moira Street West is a two-lane arterial road with an urban cross-section through the study area. Between Butler Lane and Sidney Street, sidewalk is available on the south side of the road. East of Sidney, sidewalk is available on both sides of the road. Moira Street West has a posted speed limit of 50 km/h and is under the jurisdiction of City.

Sidney Street is a four-lane arterial road with an urban cross-section through the study area. North of Wilson Avenue, sidewalk is available on the east side of the road. South of Wilson Avenue, sidewalk is available on both sides of the road. Sidney Street has a posted speed limit of 50 km/h and is under the jurisdiction of City.

Palmer Road is a two-lane collector road with an urban cross-section and sidewalk on the west side of the road through the study area. Moira Street West has a posted speed limit of 50 km/h and is under the jurisdiction of City.

Wilson Avenue is a two-lane local road with a rural cross-section through the study area. Wilson Avenue has an assumed (unposted) speed limit of 50 km/h and is under the jurisdiction of City.

Tripp Avenue is a two-lane local road with a rural cross-section and sidewalk on the west side of the road through the study area. Tripp Avenue has an assumed (unposted) speed limit of 50 km/h and is under the jurisdiction of City.

Elgin Street is a two-lane local road with and a rural cross-section through the study area. Elgin Street has an assumed (unposted) speed limit of 50 km/h and is under the jurisdiction of City.

The existing intersection spacing and lane configuration within the study area is illustrated in **Figure 2**.

Figure 2 – Existing (2022) Intersection Spacing and Lane Configuration with in Study Area

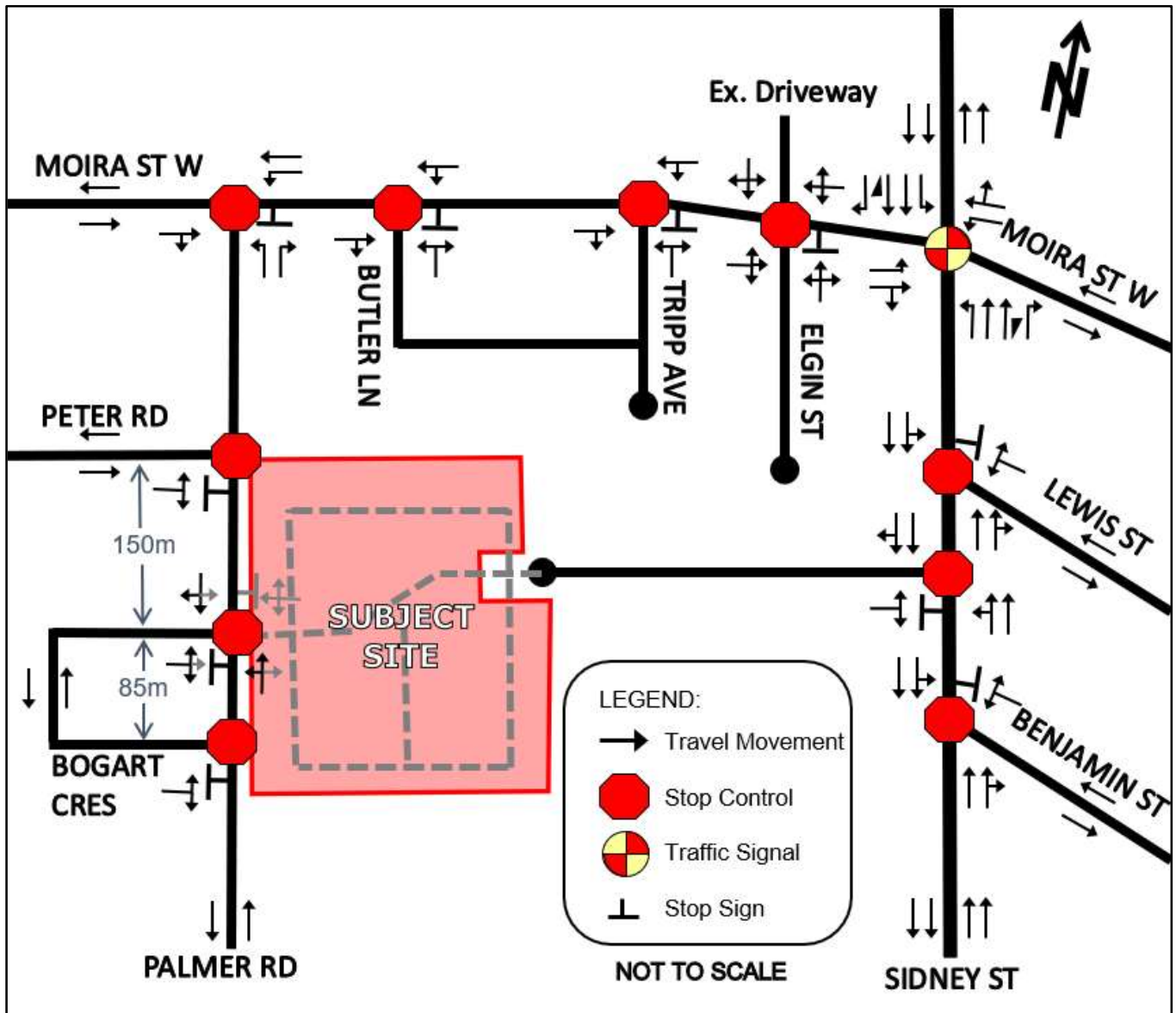

2.2 Local Transportation Infrastructure Improvements

In review of the City's Transportation Master Plan [City TMP] (April 22, 2014) and City's 2022 Capital Budget Summary, there are no planned infrastructure improvements in the study area that would impact the local traffic volumes or traffic distribution.

2.3 Transit Access

Belleville Transit provides bus service within the study area. The following transit routes are accessible for the proposed development:

- **Route 5 (Parkdale-Mall)** - traveling along Sidney Street in the study area with weekday service provided between 05:00 – 21:25 with daytime service every 45 minutes. Saturday service is provided between 05:30 – 18:55 with service every hour. Sunday service is provided between 09:00 – 18:25 with service every hour. The closest bus stop for Route 5 is located at the northeast corner of the Sidney Street / Lewis Street intersection.
- **Route 6 (Avondale)** - traveling along Sidney Street and Moira Street West in the study area with weekday service provided between 06:30 – 18:25 with daytime service every 45 minutes. Saturday service is provided between 08:00 – 18:25 with service every hour. Sunday service is provided between 09:00 – 18:25 with service every hour. The closest bus stop for Route 6 is located on Sidney Street, opposite Lewis Street.
- **Route 7 (Loyalist)** - traveling along Moira Street West in the study area with weekday service provided between 06:30 – 22:25 with daytime service every 30 minutes. Saturday service is provided between 07:00 – 19:25 with service every 30 minutes. Sunday service is provided between 09:30 – 17:55 with service every hour. The closest bus stops for Route 7 are located between Tripp Avenue and Elgin Street on Moira Street West, and on Sidney Street, opposite Lewis Street.
- **Route 10 (Loyalist/Walmart)** - traveling along Moira Street West and Palmer Road in the study area with weekday service provided between 07:30 – 21:25 with daytime service every hour. Saturday service is provided between 08:30 – 18:25 with service every hour. Sunday service is provided between 09:30 – 17:55 with service every hour. The closest bus stop for Route 10 is located on Palmer Road, south of Bogart Crescent (south).

All bus stops are located within a 350-metre radius of the Subject Site.

2.4 Development Growth

Through correspondence with City staff, the following developments have been noted for consideration with respect to impacts on the local traffic volumes / infrastructure capacity:

- Sand Cherry Court Subdivision;
- Mancuso Subdivision,
- Fairgrounds Property; and
- Ben Blecker Lands.

Figure 3 illustrates the location of the above developments in relation to the subject site.

Figure 3 – Adjacent Development Location



2.4.1 Sandy Cherry Court Subdivision

The Sandy Cherry Court Subdivision is on the east side of Palmer Road, north of the Subject Site. The proposed development has been approved to include 39 residential units with access onto Palmer Road.

Traffic volumes generated by the Sandy Cherry Court Subdivision have been established based on the data provided in the Institute of Transportation Engineers [ITE] Trip Generation Manual (10th Edition) [ITE Trip Generation Manual]. The following ITE land uses have been applied to estimate the traffic from the development:

- ITE land use 210 (Single-Family Detached Housing) – General Urban/Suburban Setting.

Given the strong statistical relationship, the fitted curve equations have been utilized. **Table 1** summarizes the utilized trip generation equations and estimated trip generation for the Sandy Cherry Court Subdivision.

Table 1 – Estimated Traffic Generation – Adjacent Development (Sandy Cherry Court Subdivision)

Land Use	Trip Basis / Size	AM Peak Hour			PM Peak Hour		
		IN	OUT	TOTAL	IN	OUT	TOTAL
Single-Family Detached ITE Land Use: 210	equation (units)	$T = 0.71 X + 4.80$			$\ln(T) = 0.96 \ln(X) + 0.2$		
	distribution	25%	75%	100%	63	37%	100%
Dominion Park Subdivision	39 units	8	24	32	26	15	41

It is anticipated that the subdivision will be fully built and occupied by the 2029 horizon year.

Traffic volumes generated by the Sandy Cherry Court Subdivision have been distributed to the study area road network based on the traffic distribution developed in Section 4.2. The assignment of the Sandy Cherry Court Subdivision volumes through the study area road network is illustrated in **Figure 4**.

2.4.2 Fairgrounds Property

The Fairground Property is located at the northwest corner of the Bridge Street West / Sidney Street intersection. City Staff has indicated that the property has not yet been approved for development. Based on the *Sidney Street Widening & Bridge Street West Intersection Improvements EA* (Ainley & Associates Limited - May 17th, 2021) [Ainley EA], the proposed development is anticipated to include:

- 135 high-density units;
- 75 single detached units;
- 0.92-hectare commercial block;
- 0.86-hectare park land;
- 50,000 ft² recreational community centre;
- Existing Curling Club to remain.

Trip generation and distribution for the development have been established based on the Ainley EA, excerpts of which are provided in **Appendix B**. It is noted that the Ainley EA assumed a build-out year of 2029 for the commercial block and recreational center, and a build-out year of 2039 for the residential and park lands. For the purpose of this study, the entire development has been assumed to be built out by the 2029 horizon year. The AM and PM peak hour traffic volumes are illustrated in **Figure 5**.

2.4.3 Ben Bleecker Lands

The Ben Bleecker Lands are located at the northeast corner of the Bridge Street West / Sidney Street intersection. City Staff has indicated that the property has not yet been approved for development. Based on the Ainley EA, the proposed development is anticipated to include a 100,000 ft² grocery store.

Trip generation and distribution for the development have been established based on the Ainley EA, excerpts of which are provided in **Appendix B**. It is noted that the Ainley EA assumed a build-out year of 2029. For the purpose of this study, the entire development has been assumed to be built out by the 2029 horizon year. The AM and PM peak hour traffic volumes are illustrated in **Figure 6**.

2.4.4 Mancuso Subdivision

The Mancuso Subdivision is on the north side of Bridge Street West, west of the Palmer Road. The proposed development has been approved to include 35 residential units with access onto Bridge Street West.

Given the location of the Mancuso Subdivision, traffic volumes generated by such will be relatively minor through the study area road network. The generated traffic has been assumed to be encompassed within the overall background growth rate noted in Section 2.5.3.

2.5 Background Traffic Growth

2.5.1 Population & Employment Growth

The 2016 census profile for the City of Belleville indicates that the population has increased from 49,454 in 2011 to 50,716 in 2016, translating to an average annual increase of 0.29%. Over the same period, the County of Hastings has experienced a population increase from 134,934 to 136,445 persons translating to an average annual increase of 0.22%.

The City of Belleville Transportation Master Plan [City TMP], projects a population increase of 24% between 2011 to 2031, translating to an annual growth rate of 1.1%. Over the same period, employment is projected to increase from 31,670 to 41,870 jobs, translating to an average annual increase of 1.41%.

2.5.2 Other Studies

The Ainley EA utilized a growth rate of 1.5% per year on Sidney Street.

2.5.3 Overall Background Growth Rate

Considering the above historical population and employment growth, growth rates utilized in similar traffic studies in the local area, and in recognition of the consideration given to the adjacent development growth, a growth rate of 1.5% per annum has been assumed for Sidney Street, Moira Street and Palmer Road within the study area. No growth has been applied to the local roads.

2.6 Traffic Counts

Detailed turning movement traffic and pedestrian counts were commissioned by JD Engineering at the study intersections. **Table 2** summarizes the traffic count data collection information.

Table 2 – Traffic Count Data

Intersection (N-S Street / E-W Street)	Count Date	AM Peak Hour	PM Peak Hour	Source
Palmer Road / Bogart Crescent (north)	Tuesday, June 22, 2021	07:30 – 08:30	16:15 – 17:15	JD Eng. ¹
Tripp Ave / Moira St W	Tuesday, June 22, 2021	07:30 – 08:30	16:30 – 17:30	JD Eng. ¹
Elgin St / Moira St W	Tuesday, June 22, 2021	07:30 – 08:30	16:00 – 17:00	JD Eng. ¹
Sidney St / Wilson Ave	Tuesday, June 22, 2021	08:00 – 09:00	16:00 – 17:00	JD Eng. ¹
Sidney Street / Bridge St W ² (north leg only)	Tuesday, June 22, 2021	07:45 – 08:45	16:30 – 17:30	JD Eng. ¹

¹Counts were completed by Accu-Traffic Inc. on behalf of JD Engineering.

²Although the intersection of Sidney Street / Bridge St W is not explicitly analyzed in this study, traffic counts were conducted at the intersection to evaluate the existing travel patterns in the area.

Detailed traffic count data can be found in **Appendix C**. Heavy vehicle percentages from the traffic count data have also been included in the Synchro analysis.

Recognizing that the timing of the traffic counts coincides with the physical distancing requirements related to the COVID-19 pandemic, the traffic counts conducted at the north leg of the Sidney Street / Bridge Street West intersection were compared to those available within the Ainley EA (conducted in May of 2019, prior to the COVID pandemic) in order to consider any traffic volume adjustments necessary in developing typical roadway conditions. In review of such volumes, it was found that the 2021 northbound and southbound volumes on Sidney Street fall below the 2019 volumes (with consideration for the 1.5% per annum growth rate) by an average of 37%.

Consequently, an increase of 37% has been applied to all counts conducted in June of 2021, for both the AM and PM peak hours.

2.7 Existing Traffic Volumes

The 2022 existing AM and PM peak hour traffic volumes in the study area are illustrated in **Figure 6**, established based on the June 2021 counts, adjusted to reflect the annual background growth rate noted in Section 2.5, the effects of the COVID-19 pandemic as outlined in Section 2.6.

2.8 Horizon Year Traffic Volumes

The background (2029 and 2034) horizon year traffic volumes are illustrated in **Figure 7** through **Figure 9**. The background volumes are based on the June 2021 counts, adjusted to reflect the annual background growth rate noted in Section 2.5, the effects of the COVID-19 pandemic as outlined in Section 2.6 and the traffic volumes generated by the existing adjacent developments as noted in Section 2.4.

3 Intersection Operation without Proposed Development

3.1 Introduction

Existing and background horizon operational conditions were established to determine how the street network within the study area is currently functioning without the proposed development. This provides a base case scenario to compare with future development scenarios. Traffic operations within the study area were evaluated using the existing and future background traffic volumes with the existing road configuration and traffic control. The intersection performance was measured using the traffic analysis software, Synchro 11, a deterministic model that employs Highway Capacity Manual and Intersection Capacity Utilization methodologies for analyzing intersection operations. These procedures are accepted by provincial and municipal agencies throughout North America.

Synchro 11 enables the study area to be graphically defined in terms of streets and intersections, along with their geometric and traffic control characteristics. The user is able to evaluate both signalized and unsignalized intersections in relation to each other, thus not only providing level of service for the individual intersections, but also enabling an assessment of the impact the various intersections in a network have on each other in terms of spacing, traffic congestion, delay, and queuing.

The intersection operations were also evaluated in terms of the LOS. LOS is a common measure of the quality of performance at an intersection and is defined in terms of vehicular delay. This delay includes deceleration delay, queue move-up time, stopped delay, and acceleration delay. LOS is expressed on a scale of A through F, where LOS A represents very little delay (i.e. less than 10 seconds per vehicle) and LOS F represents very high delay (i.e. greater than 50 seconds per vehicle for a stop sign controlled intersection and greater than 80 seconds per vehicle for a signalized intersection).

The LOS criteria for signalized and stop sign-controlled intersections are shown in **Table 3**. A description of traffic performance characteristics is included for each LOS.

Table 3 – Level of Service Criteria for Intersections

LOS	LOS Description	Control Delay (seconds per vehicle)	
		Signalized Intersections	Stop Controlled Intersections
A	Very low delay; most vehicles do not stop (Excellent)	less than 10.0	less than 10.0
B	Higher delay; more vehicles stop (Very Good)	between 10.0 and 20.0	between 10.0 and 15.0
C	Higher level of congestion; number of vehicles stopping is significant, although many still pass through intersection without stopping (Good)	between 20.0 and 35.0	between 15.0 and 25.0
D	Congestion becomes noticeable; vehicles must sometimes wait through more than one red light; many vehicles stop (Satisfactory)	between 35.0 and 55.0	between 25.0 and 35.0
E	Vehicles must often wait through more than one red light; considered by many agencies to be the limit of acceptable delay	between 55.0 and 80.0	between 35.0 and 50.0
F	This level is considered to be unacceptable to most drivers; occurs when arrival flow rates exceed the capacity of the intersection (Unacceptable)	greater than 80.0	greater than 50.0

3.2 Existing Intersection Operation

The results of the LOS analysis under existing (2022) traffic volumes during the AM and PM peak hour can be found below in **Table 4**. Existing intersection geometry and traffic control have been utilized for this scenario. Detailed output of the Synchro analysis can be found in **Appendix D**.

The results of the LOS analysis indicate that the study intersections are operating within the typical design limits noted in Section 3.1.

An analysis was completed for left turn movements at the unsignalized intersections, based on the criteria outlined in Appendix 9A of the Ontario Ministry of Transportation Design Supplement for TAC Geometric Design Guide for Canadian Roads June 2017 [MTO DS]. A design speed of 60km/h was utilized for the westbound and southbound directions on Moira Street West and Sidney Street, respectively (speed limit + 10 km/h for lower speed roads). Based on MTO DS criteria, exclusive left turn lanes are not warranted at the study intersections (results provided in **Appendix G**). The exception occurs at the Moira Street West / Tripp Avenue intersection during the PM peak hour. However, recognizing that the all movements at the intersection will provide good operations with negligible queuing in the westbound direction (LOS A or greater, 95th percentile queue length < 1.3 metres) and further noting that the warrant is only triggered during the PM peak hour, the implementation of a westbound left turn lane is not recommended.

A review of the need for an additional auxiliary right turn lanes at the unsignalized intersections was completed as part of our analysis. The results of the Synchro analysis indicate that there is excess capacity for all turning movements; consequently, auxiliary right turn lanes are not recommended.

Further consideration for traffic signal improvements were considered at the unsignalized intersection based on the Ontario Traffic Manual Book 12 *Signal Justification*. The results indicate that traffic signals are not warranted at the intersection (results are provided in **Appendix H**).

Table 4 – Existing (2022) LOS

Location (N-S Street / E-W Street)	Weekday AM Peak Hour			Weekday PM Peak Hour		
	V/C	Delay (s)	LOS	V/C	Delay (s)	LOS
Palmer Rd / Bogart Cres (unsignalized)	-	0.9	A	-	0.4	A
EB	0.02	9.3	A	0.01	10.2	B
NB	0.00	0.0	-	0.01	0.5	A
SB	0.06	0.0	-	0.14	0.0	-
Sidney St / Wilson Ave (unsignalized)	-	0.3	A	-	0.3	A
EB	0.03	11.5	B	0.06	18.8	C
NBTL	0.01	0.2	A	0.00	0.2	A
NB	0.18	0.0	-	0.34	0.0	-
SB	0.19	0.0	-	0.22	0.0	-
SBTR	0.11	0.0	-	0.12	0.0	-
Tripp Ave / Moira St W (unsignalized)	-	0.8	A	-	1.4	B
EBTR	0.22	0.0	-	0.26	0.0	-
WBTL	0.02	0.6	A	0.05	1.4	A
NB	0.05	10.7	B	0.10	12.0	B
Elgin St & Driveway / Moira St W (unsignalized)	-	0.6	A	-	1.3	A
EB	0.00	0.0	-	0.00	0.1	A
WB	0.01	0.2	A	0.02	0.5	A
NB	0.03	12.0	B	0.06	15.2	C
SB	0.04	15.5	C	0.16	23.6	C

3.3 Background (2029) Intersection Operation

The results of the LOS analysis under background (2029) traffic volumes during the AM and PM peak hour can be found below in **Table 5**. Existing intersection geometry and traffic control have been utilized for this scenario. Detailed output of the Synchro analysis can be found in **Appendix D**.

The results of the LOS analysis indicate that the study intersections are operating within the typical design limits noted in Section 3.1.

The need for a left turn lanes was again analyzed to consider the background 2029 traffic volumes. Based on the MTO DS criteria exclusive left turn lanes are not warranted at the study intersections (results provided in **Appendix G**). Again, the exception occurs at the Moira Street West / Tripp Avenue intersection during the PM peak hour. However, recognizing that the all movements at the intersection will provide good operations with negligible queuing in the westbound direction (LOS A or greater, 95th percentile queue length < 1.4 metres) and further noting that the warrant is only triggered during the PM peak hour, the implementation of a westbound left turn lane is not considered necessary.

A review of the need for an additional auxiliary right turn lanes at the unsignalized intersections was completed as part of our analysis. The results of the Synchro analysis indicate that there is excess capacity for all turning movements; consequently, auxiliary right turn lanes are not recommended.

Further consideration for traffic signal improvements were considered at the unsignalized intersection based on the Ontario Traffic Manual Book 12 *Signal Justification*. The results indicate that traffic signals are not warranted at the intersection (results are provided in **Appendix H**).

Table 5 – Background (2029) LOS

Location (N-S Street / E-W Street)	Weekday AM Peak Hour			Weekday PM Peak Hour		
	V/C	Delay (s)	LOS	V/C	Delay (s)	LOS
Palmer Rd / Bogart Cres (unsignalized)	-	0.8	A	-	0.4	A
EB	0.03	9.5	A	0.02	10.5	B
NB	0.00	0.0	-	0.01	0.4	A
SB	0.07	0.0	-	0.15	0.0	-
Sidney St / Wilson Ave (unsignalized)	-	0.3	A	-	0.3	A
EB	0.04	12.9	B	0.10	27.5	D
NBTL	0.01	0.4	A	0.00	0.2	A
NB	0.23	0.0	-	0.43	0.0	-
SB	0.24	0.0	-	0.30	0.0	-
SBTR	0.13	0.0	-	0.16	0.0	-
Tripp Ave / Moira St W (unsignalized)	-	0.7	A	-	1.4	C
EBTR	0.25	0.0	-	0.30	0.0	-
WBTL	0.02	0.6	A	0.06	1.5	A
NB	0.06	11.2	B	0.11	13.0	B
Elgin St & Driveway / Moira St W (unsignalized)	-	0.6	A	-	1.4	A
EB	0.00	0.0	-	0.01	0.1	A
WB	0.01	0.2	A	0.02	0.5	A
NB	0.03	12.9	B	0.07	17.5	C
SB	0.05	17.6	C	0.21	30.1	D

3.4 Background (2034) Intersection Operation

The results of the LOS analysis under background (2034) traffic volumes during the AM and PM peak hour can be found below in **Table 4**. Existing intersection geometry and traffic control have been utilized for this scenario. Detailed output of the Synchro analysis can be found in **Appendix D**.

The results of the LOS analysis indicate that the study intersections are operating within the typical design limits noted in Section 3.1.

The need for a left turn lanes was again analyzed to consider the background 2034 traffic volumes. Based on the MTO DS criteria exclusive left turn lanes are not warranted at the study intersections (results provided in **Appendix G**). Again, the exception occurs at the Moira Street West / Tripp Avenue intersection during the PM peak hour. However, recognizing that the all movements at the intersection will provide good operations with negligible queuing in the westbound direction (LOS A or greater, 95th percentile queue length < 1.4 metres) and further noting that the warrant is only triggered during the PM peak hour, the implementation of a westbound left turn lane is not considered necessary.

A review of the need for an additional auxiliary right turn lanes at the unsignalized intersections was completed as part of our analysis. The results of the Synchro analysis indicate that there is excess capacity for all turning movements; consequently, auxiliary right turn lanes are not recommended.

Further consideration for traffic signal improvements were considered at the unsignalized intersection based on the Ontario Traffic Manual Book 12 *Signal Justification*. The results indicate that traffic signals are not warranted at the intersection (results are provided in **Appendix H**).

Table 6 – Background (2034) LOS

Location (N-S Street / E-W Street)	Weekday AM Peak Hour			Weekday PM Peak Hour		
	V/C	Delay (s)	LOS	V/C	Delay (s)	LOS
Palmer Rd / Bogart Cres (unsignalized)	-	0.7	A	-	0.4	A
EB	0.03	9.6	A	0.02	10.7	B
NB	0.00	0.0	-	0.01	0.4	A
SB	0.07	0.0	-	0.17	0.0	-
Sidney St / Wilson Ave (unsignalized)	-	0.3	A	-	0.3	A
EB	0.04	13.4	B	0.11	30.8	D
NBTL	0.01	0.4	A	0.01	0.2	A
NB	0.25	0.0	-	0.46	0.0	-
SB	0.25	0.0	-	0.32	0.0	-
SBTR	0.14	0.0	-	0.17	0.0	-
Tripp Ave / Moira St W (unsignalized)	-	0.7	A	-	1.4	B
EBTR	0.27	0.0	-	0.32	0.0	-
WBTL	0.02	0.6	A	0.06	1.5	A
NB	0.06	11.5	B	0.12	13.5	B
Elgin St & Driveway / Moira St W (unsignalized)	-	0.6	A	-	1.5	A
EB	0.00	0.0	-	0.01	0.1	A
WB	0.01	0.2	A	0.02	0.5	A
NB	0.03	13.5	B	0.08	19.0	C
SB	0.05	18.9	C	0.23	34.7	D

4 Proposed Development Traffic Generation and Assignment

4.1 Traffic Generation

As previously mentioned, the development will include 82 single detached units and 71 townhouse units

The traffic generation for the subject site has been based on the ITE Trip Generation Manual. The following ITE land use has been applied to estimate the traffic from the proposed development:

- ITE land use 210 (Single Family Detached) – General Urban / Suburban Setting; and
- ITE land use 220 (Multifamily Housing (Low-Rise)) – General Urban / Suburban Setting;

The traffic rates and equations are summarized in **Table 7** and **Table 8**.

Table 7 – Estimated Traffic Generation of Proposed Development

Land Use	Trip Basis / Units	AM Peak Hour			PM Peak Hour		
		IN	OUT	TOTAL	IN	OUT	TOTAL
Single-Family Detached ITE Land Use: 210	equation (units)	Ln(T) = 0.91 Ln(X) + 0.12			Ln(T) = 0.94 Ln(X) + 0.27		
	distribution	26%	74%	100%	63%	37%	100%
Multifamily Housing (Low-Rise) ITE Land Use: 220	equation (units)	T = 0.31(X) + 22.85			T = 0.43 (X) + 20.55		
	distribution	24%	76%	100%	63%	37%	100%

The estimated trip generation for the proposed development is illustrated below in **Table 8**.

Table 8 – Estimated Traffic Generation of Proposed Development

Land Use	Size	AM Peak Hour			PM Peak Hour		
		IN	OUT	TOTAL	IN	OUT	TOTAL
Single-Family Detached ITE Land Use: 210	86 units ¹	17	48	65	54	32	86
Multifamily Housing (Low-Rise) ITE Land Use: 220	71 units	11	34	45	32	19	51
Total		28	82	110	86	51	137

As shown, the proposed residential development is expected to generate 110 trips and 137 trips during the AM and PM peak hours, respectively. No transportation modal split has been applied to the above-noted traffic generation calculation.

4.2 Traffic Assignment

For the purposes of this study, it has been assumed that all traffic generated by the proposed development will be new traffic and would not be in the study area if the development was not constructed.

Traffic distribution for the trips generated by the proposed development have been developed based on existing traffic flow observed at the study area intersections in conjunction with the site's location within the City of Belleville and proximity to surrounding development, attractions and major travel routes (i.e. Highway 401 to the north).

The distribution of trips is illustrated in **Table 9** using the methodology outlined above.

¹ The development details of the proposed development are based on a previous iteration of the Site Plan, where additional single-detached units were proposed. Consequently, the noted traffic generation provides a conservative estimate.

Table 9 – Proposed Development Traffic Distribution

Access	Travel Direction (to / from)	Percent of Total Traffic Generation
Wilson Avenue	North via Sidney St	25%
	South via Sidney St	25%
Wilson Avenue Extension	North via Palmer Rd	25%
	South via Palmer Rd	25%
TOTAL		100%

The site traffic assignment for buildout of the proposed developments for the AM and PM peak hour is illustrated in **Figure 10**.

4.3 Total Horizon Year Traffic Volumes with the Proposed Development

For the total (2029 and 2034) horizon year traffic volumes, the proposed development traffic was added to the background (2029 and 2034) traffic volumes. The resulting total (2029 and 2034) horizon year traffic volume for the AM and PM peak hour are illustrated in **Figure 11** and **Figure 12**.

5 Intersection Operation with Proposed Development

5.1 Total (2029) Intersection Operation

The results of the LOS analysis under total (2029) traffic volumes during the AM and PM peak hour can be found below in **Table 10**. Existing intersection geometry has been utilized for this scenario, including stop control has been assumed at the Site Access egress movements. Detailed output of the Synchro analysis can be found in **Appendix F**.

Table 10 – Total (2029) LOS

Location (N-S Street / E-W Street)	Weekday AM Peak Hour			Weekday PM Peak Hour		
	V/C	Delay (s)	LOS	V/C	Delay (s)	LOS
Palmer Rd / Bogart Cres & Wilson Ave ext. (unsignalized)	-	2.3	A	-	1.3	A
EB	0.03	9.9	A	0.02	11.4	B
WB	0.06	9.8	A	0.04	11.1	B
NB	0.00	0.0	-	0.01	0.4	A
SB	0.01	0.5	A	0.02	0.8	A
Sidney St / Wilson Ave (unsignalized)	-	0.9	A	-	0.9	B
EB	0.16	15.8	C	0.24	30.2	D
NBTL	0.02	0.8	A	0.03	1.1	A
NB	0.23	0.0	-	0.43	0.0	-
SB	0.24	0.0	-	0.30	0.0	-
SBTR	0.14	0.0	-	0.17	0.0	-
Tripp Ave / Moira St W (unsignalized)	-	0.7	A	-	1.4	C
EBTR	0.26	0.0	-	0.30	0.0	-
WBTL	0.01	0.4	A	0.06	1.5	A
NB	0.06	11.3	B	0.11	13.0	B
Elgin St & Driveway / Moira St W (unsignalized)	-	0.6	A	-	1.4	A
EB	0.00	0.0	-	0.01	0.1	A
WB	0.01	0.2	A	0.02	0.5	A
NB	0.03	13.0	B	0.07	17.6	C
SB	0.05	17.7	C	0.21	30.5	D

The results of the LOS analysis indicate that the study intersections are operating within the typical design limits noted in Section 3.1.

The need for a left turn lanes was again analyzed to consider the total 2029 traffic volumes. A summary of the left turn lane analysis is provided in **Table 11**.

Table 11 – Total (2029) Left Turn Analysis Summary

Peak Hour	Intersection (N-S Street / E-W Street)	Direction	% Left Turns / Left turn volume	Left Turn Movement				Warrant
				V/C	Delay (s)	LOS	95 th % queue (m)	
AM	Sidney St / Wilson Ave	NB	14 veh	0.02	0.8	A	0.4	X
PM			26 veh	0.03	1.1	A	0.8	✓
AM	Tripp Ave / Moira St W	WB	4.3%	0.02	0.6	A	0.4	X
PM			8.4%	0.06	1.5	A	1.4	✓
AM	Elgin St & Driveway / Moira St W	WB	1.7%	0.01	0.2	A	0.2	X
PM			2.7%	0.02	0.5	A	0.4	✓ ¹

¹The PM peak hour volumes fall below the 5% left turn threshold.

As shown, based on the MTO DS criteria exclusive left turn lanes are warranted during the PM peak hours. However, recognizing that the all movements at the intersection will provide good operations with negligible queuing and further noting that the warrant is only triggered during the PM peak hour, the implementation of an exclusive left turn lane is not recommended. It is further noted that the warrants are sensitive to the conservative background growth rate, adjacent development volumes and COVID-19 adjustment factor assumed in Section 2.4, 2.5.3 and 2.6. Consequently, it is recommended that the need for left turn lanes be evaluated based on continued traffic volume monitoring of City roads, as development occurs.

A review of the need for an additional auxiliary right turn lanes at the unsignalized intersections was completed as part of our analysis. The results of the Synchro analysis indicate that there is excess capacity for all turning movements; consequently, auxiliary right turn lanes are not recommended.

Based on the Ontario Traffic Manual Book 12 *Signal Justification*, traffic signals are not warranted at the remaining unsignalized intersections (results are provided in **Appendix G**). No additional improvements are recommended within the study area.

5.2 Total (2034) Intersection Operation

The results of the LOS analysis under total (2034) traffic volumes during the AM and PM peak hour can be found below in **Table 12**. Existing intersection geometry has been utilized for this scenario, including stop control has been assumed at the Site Access egress movements. Detailed output of the Synchro analysis can be found in **Appendix F**.

Table 12 – Total (2034) LOS

Location (N-S Street / E-W Street)	Weekday AM Peak Hour			Weekday PM Peak Hour		
	V/C	Delay (s)	LOS	V/C	Delay (s)	LOS
Palmer Rd / Bogart Cres & Wilson Ave ext. (unsignalized)	-	2.2	A	-	1.3	A
EB	0.03	10.0	B	0.02	11.6	B
WB	0.06	9.9	A	0.05	11.4	B
NB	0.00	0.0	-	0.01	0.4	A
SB	0.01	0.5	A	0.02	0.7	A
Sidney St / Wilson Ave (unsignalized)	-	0.9	A	-	1.0	A
EB	0.17	16.8	C	0.27	34.5	B
NBTL	0.02	0.8	A	0.04	0.4	A
NB	0.25	0.0	-	0.46	0.0	-
SB	0.25	0.0	-	0.32	0.0	-
SBTR	0.14	0.0	-	0.18	0.0	-
Tripp Ave / Moira St W (unsignalized)	-	0.7	A	-	1.4	D
EBTR	0.28	0.0	-	0.33	0.0	-
WBTL	0.02	0.7	A	0.06	1.5	A
NB	0.06	11.6	B	0.12	3.6	B
Elgin St & Driveway / Moira St W (unsignalized)	-	0.6	A	-	1.5	B
EB	0.00	0.0	-	0.01	0.1	A
WB	0.01	0.2	A	0.02	0.5	A
NB	0.03	13.5	B	0.08	19.1	C
SB	0.06	19.1	C	0.24	35.3	E

The results of the LOS analysis indicate that the study intersections are operating within the typical design limits noted in Section 3.1.

The need for a left turn lanes was again analyzed to consider the total 2034 traffic volumes. A summary of the left turn lane analysis is provided in **Table 13**.

Table 13 – Total (2034) Left Turn Analysis Summary

Peak Hour	Intersection (N-S Street / E-W Street)	Direction	% Left Turns / Left turn volume	Left Turn Movement				Warrant
				V/C	Delay (s)	LOS	95 th % queue (m)	
AM	Sidney St / Wilson Ave	NB	14 veh	0.02	0.8	A	0.4	X
PM			26 veh	0.04	1.1	A	0.8	✓
AM	Tripp Ave / Moira St W	WB	4.3%	0.02	0.6	A	0.4	X
PM			8.4%	0.06	1.5	A	1.4	✓
AM	Elgin St & Driveway / Moira St W	WB	1.6%	0.01	0.2	A	0.2	X
PM			2.5%	0.02	0.5	A	0.4	✓ ¹

¹The PM peak hour volumes fall below the 5% left turn threshold.

As shown, based on the MTO DS criteria exclusive left turn lanes are warranted during the PM peak hour. However, recognizing that the all movements at the intersection will provide good operations with negligible queuing and further noting that the warrant is only triggered during the PM peak hour, the implementation of a westbound left turn lane is not considered necessary. It is further noted that the warrants are sensitive to the conservative background growth rate, adjacent development volumes and COVID-19 adjustment factor assumed in Section 2.4, 2.5.3 and 2.6. Consequently, it is recommended that the need for left turn lanes be evaluated based on continued traffic volume monitoring of City roads, as development occurs.

A review of the need for an additional auxiliary right turn lanes at the unsignalized intersections was completed as part of our analysis. The results of the Synchro analysis indicate that there is excess capacity for all turning movements; consequently, auxiliary right turn lanes are not recommended.

Based on the Ontario Traffic Manual Book 12 *Signal Justification*, traffic signals are not warranted at the remaining unsignalized intersections (results are provided in **Appendix G**). No additional improvements are recommended within the study area.

5.3 Site Access & Intersection Spacing

The Palmer Road / Bogart Crescent & Wilson Avenue extension intersection will operate efficiently as a four-legged intersection, with one-way stop control for eastbound and westbound egress movements. A single ingress and egress lane will provide the necessary capacity to service the proposed development.

As illustrated in **Figure 3**, the spacing between the proposed Wilson Avenue extension and the closest intersections to the north and south are in excess of the minimum intersection spacing requirements as identified in the Transportation Association of Canada Design Guide for Canadian Roads (2017) [TAC Guidelines] – Section 9.4.2.2 – 60 metres for collector roads.

The majority of the Subject Sites internal intersections are in excess of the minimum intersection spacing requirements as identified in the TAC Guidelines – Section 9.4.2.3 – 40 and 60 metres for three-legged and four-legged intersections on local roads, respectively. The spacing between Palmer

Road and Street B falls slightly below the minimum intersection spacing requirement of 60 metres. However, in context with the relatively minor traffic volumes projected along the Wilson Avenue extension (42 vehicles per lane or less, during both peak hours) and the excellent operations at the Wilson Avenue extension / Palmer Road intersection (LOS B or greater for all horizon years), the proposed spacing is not a considered a concern.

5.4 Sight Distance Review

A review of the available sight distances for the Site Access connections was completed as part of this analysis.

The sight distance north and south on Palmer Road at the Wilson Avenue extension is greater than both the minimum stopping sight distance requirements as per the TAC Guidelines for a design speed of 60 km/h (85 metres).

The majority of the Subject Sites internal intersections are expected to surpass the minimum stopping sight distance requirements as per the TAC Guidelines for a design speed of 60 km/h (85 metres). The sight distance for northbound traffic on Street D, looking west, is limited by the horizontal curve on Wilson Avenue. The sight distance in this direction will need to be reviewed as part of the detailed engineering design. Traffic calming measures on Wilson Avenue and additional daylighting on the north lot in Block 95 may be required.

It is recommended that the sight distances be confirmed once detailed engineering design drawings for the proposed intersections are available.

6 Summary

ROMPSEN retained **JD Engineering** to prepare this traffic impact study in support of the proposed residential development located on located between Palmer Road and Sydney Street, south of Moira Street, in the City of Belleville. The proposed Concept Plan is shown in **Appendix A**. This chapter summarizes the conclusions and recommendations from the study.

1. The proposed development is expected to generate a total of 110 AM and 137 PM peak hour trips.
2. Detailed intersection counts were conducted at the study intersections.
3. An intersection operation analysis was completed at the study area intersections, using the existing and background (2029 and 2034) traffic volumes, with consideration for the projected adjacent development traffic growth and without the proposed development traffic. This enabled a review of existing and future traffic deficiencies that would be present without the influence of the proposed development. No improvements are recommended within the study area.
4. An estimate of the amount of traffic that would be generated by the Subject Site was prepared and assigned to the study area streets and intersections.
5. An intersection operation analysis was completed under total (2029 and 2034) traffic volumes with the proposed development operational at the study area intersections. No improvements recommended within the study area.
6. The proposed Wilson Avenue extension will operate efficiently as a four-legged intersection, with one-way stop control for eastbound and westbound egress movements. A single lane for ingress and egress movements will provide the necessary capacity to convey the traffic volume generated by the proposed development.

7. The location of the Wilson Avenue extension is considered appropriate with respect to minimum corner clearance and spacing requirements as identified in the Transportation Association of Canada Design Guide for Canadian Roads (2017).
8. In summary, the proposed development will not cause any operational issues and will not add significant delay or congestion to the local roadway network.

Figure 4: Adjacent Development Traffic Volumes – Sandy Cherry Court Subdivision

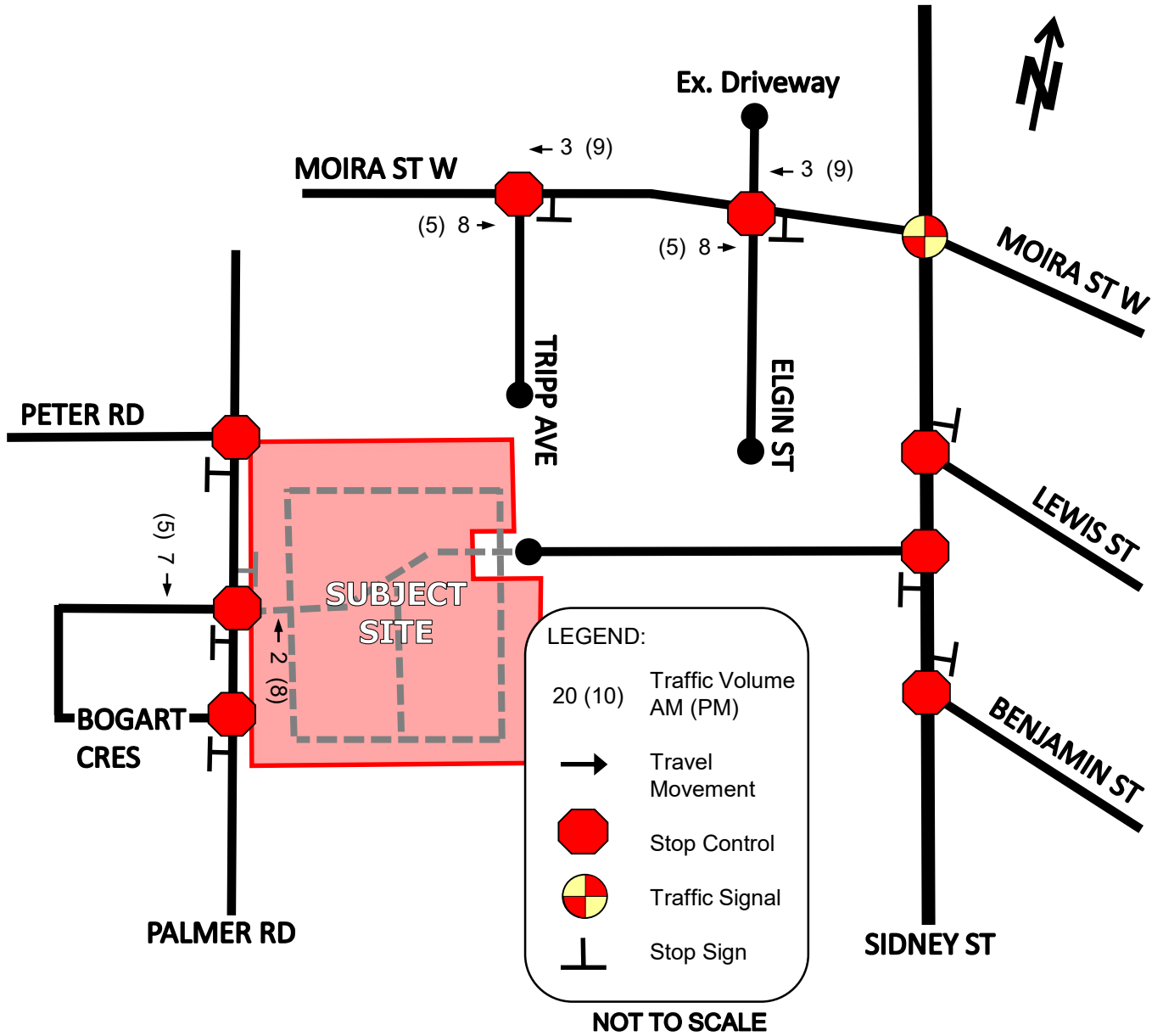

Figure 5: Adjacent Development Traffic Volumes – Fairgrounds Property

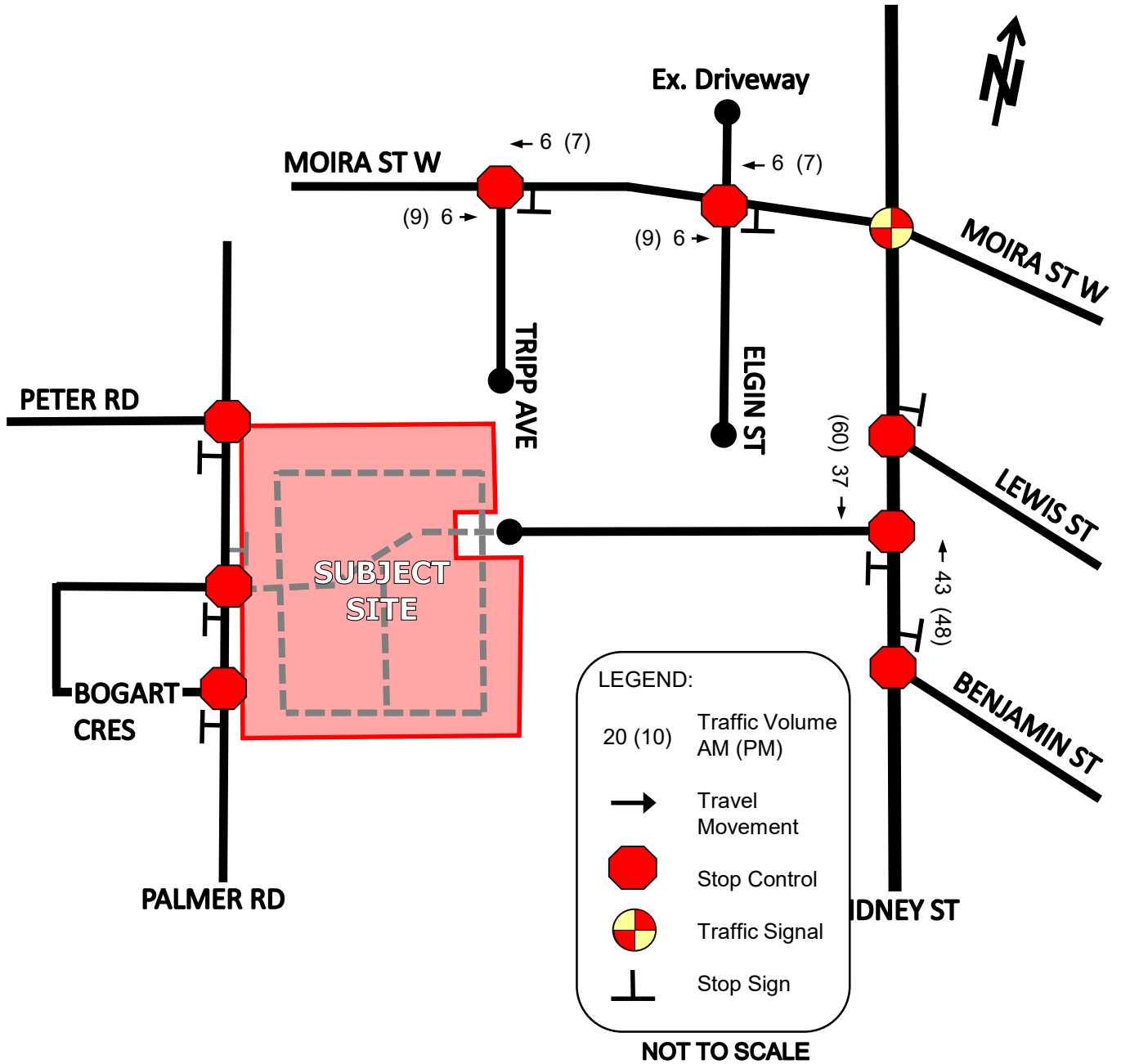

Figure 6: Adjacent Development Traffic Volumes – Ben Bleeker Lands

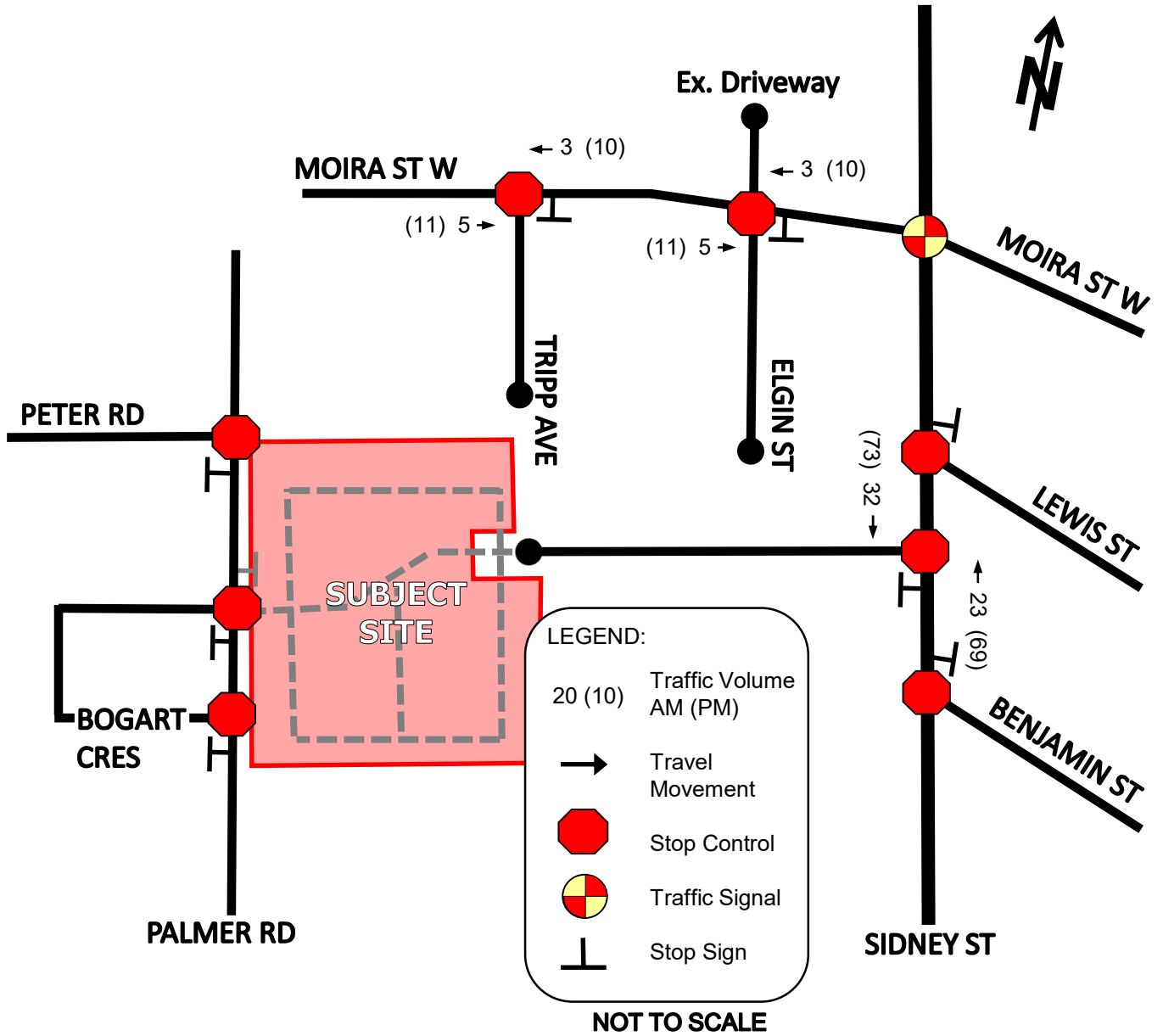

Figure 7: Existing (2022) Traffic Volumes

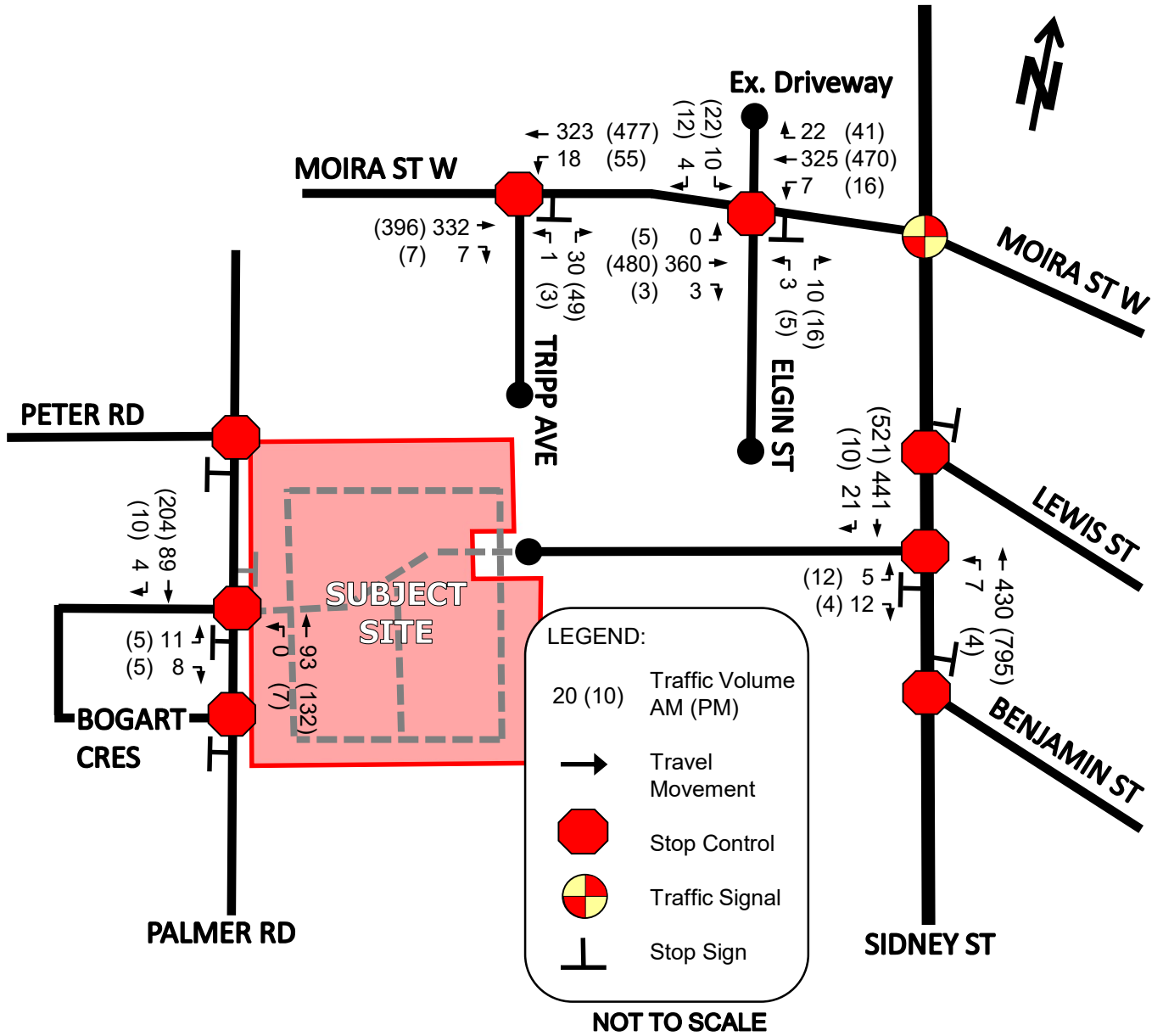

Figure 8: Background (2029) Traffic Volumes

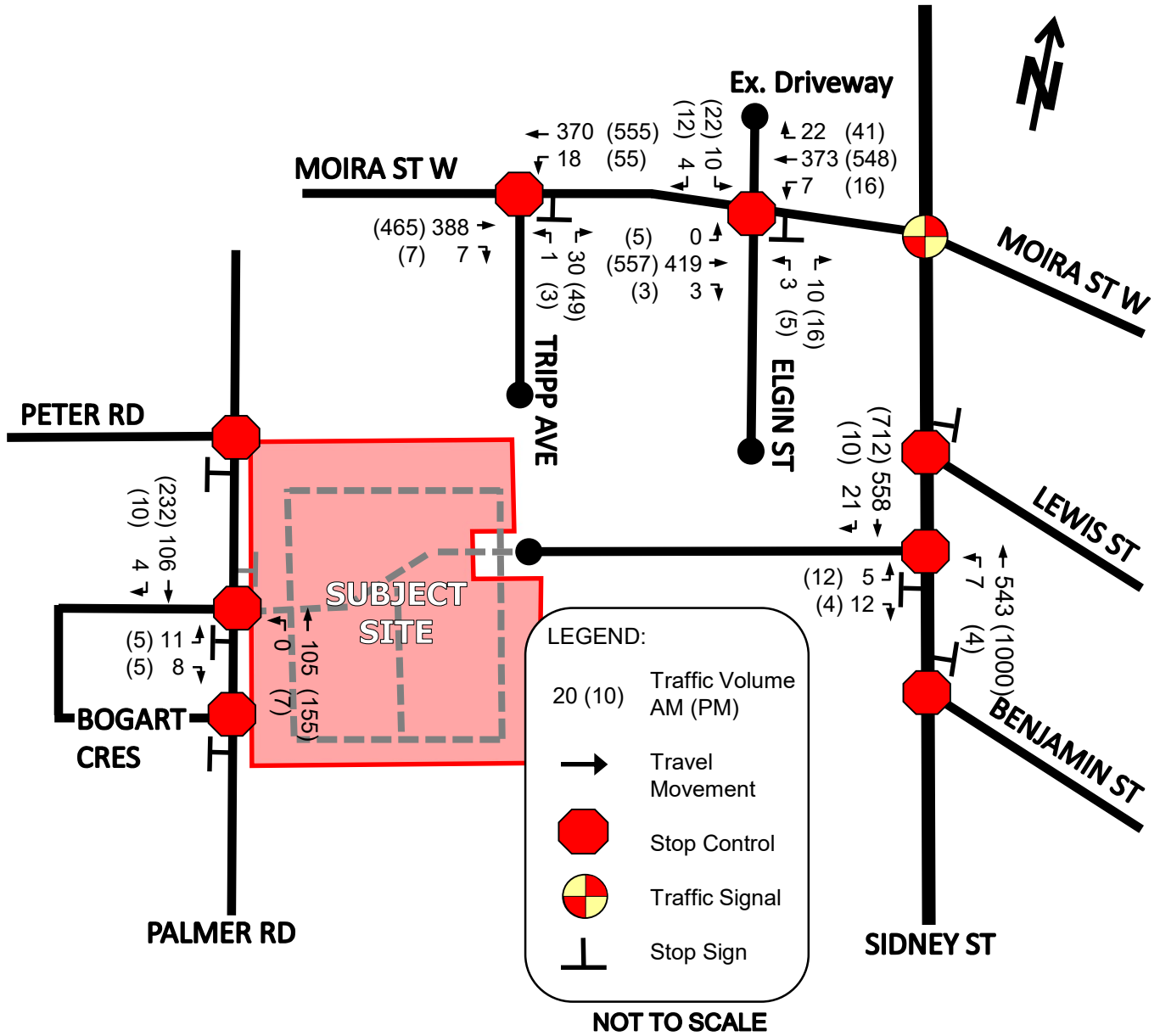

Figure 9: Background (2034) Traffic Volumes

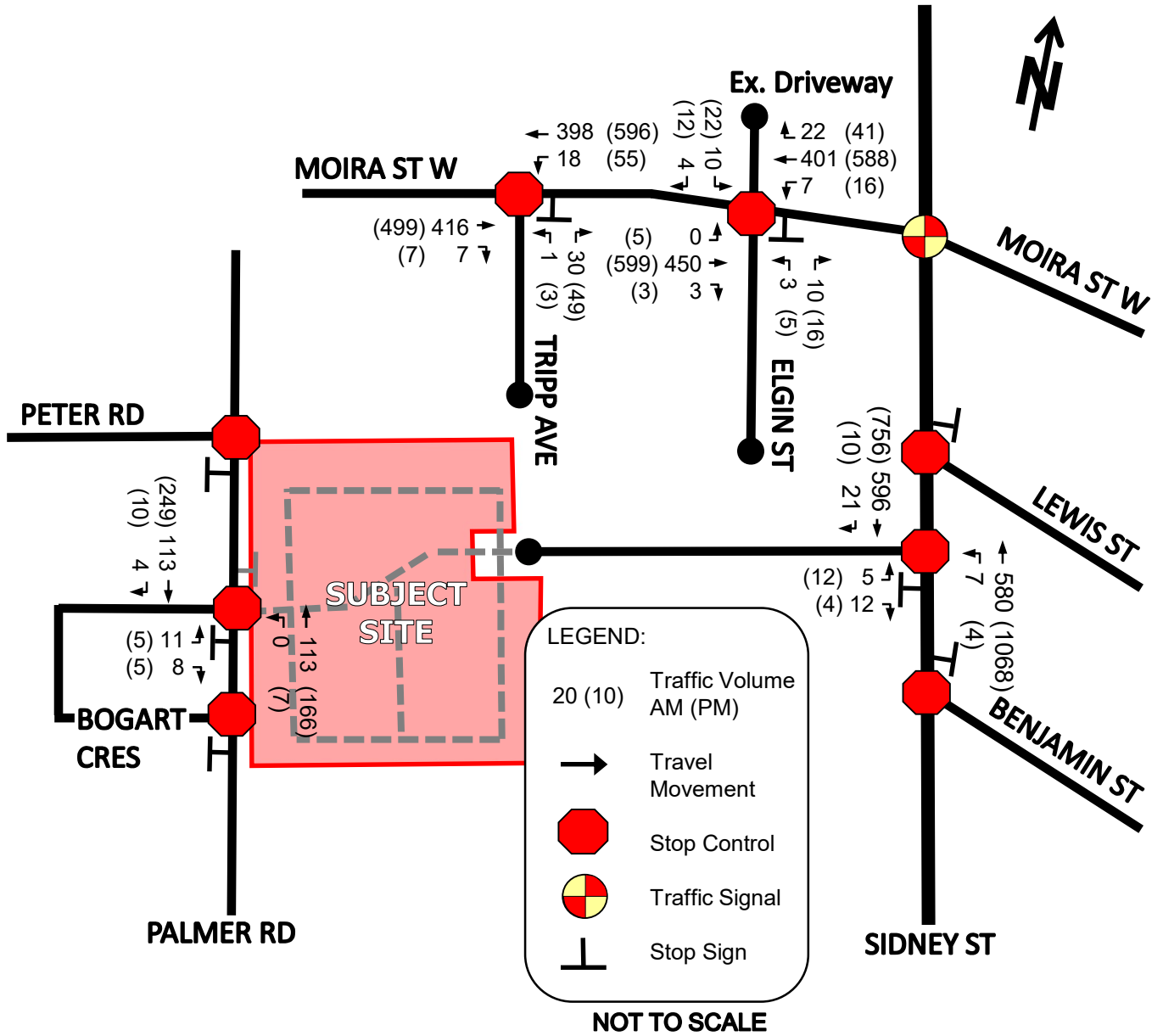

Figure 10: Site Traffic Assignment

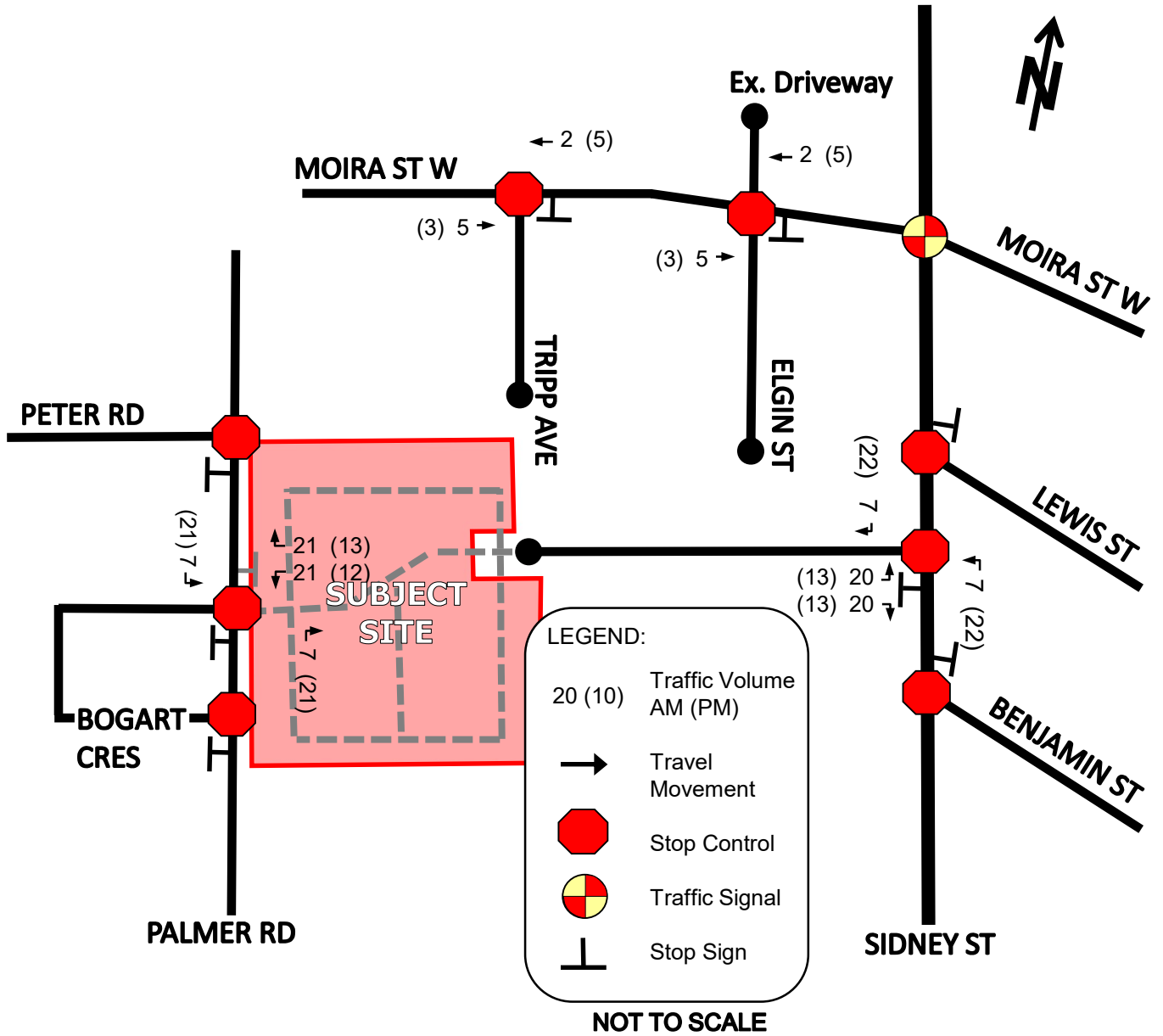

Figure 11: Total (2029) Traffic Volumes

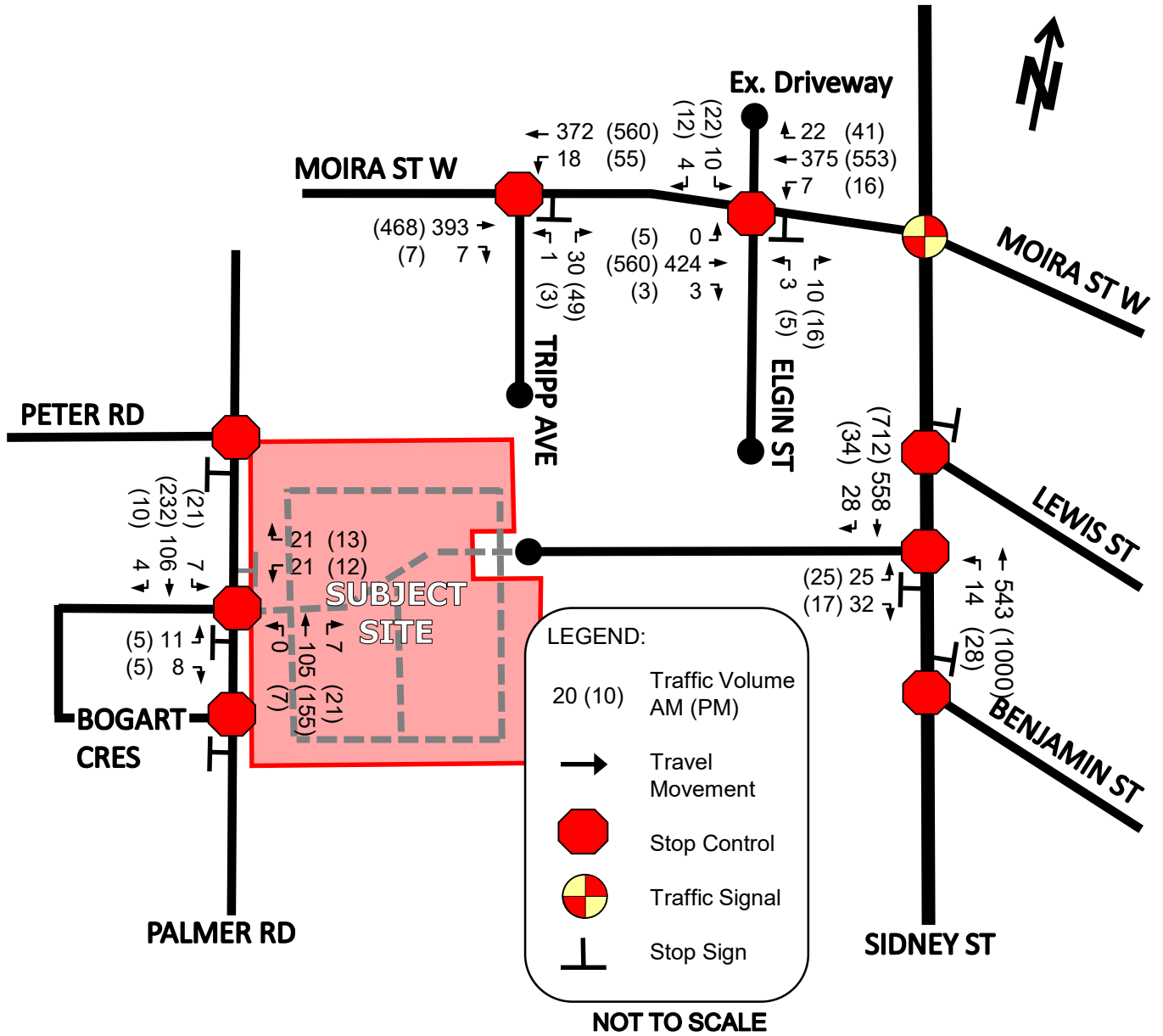
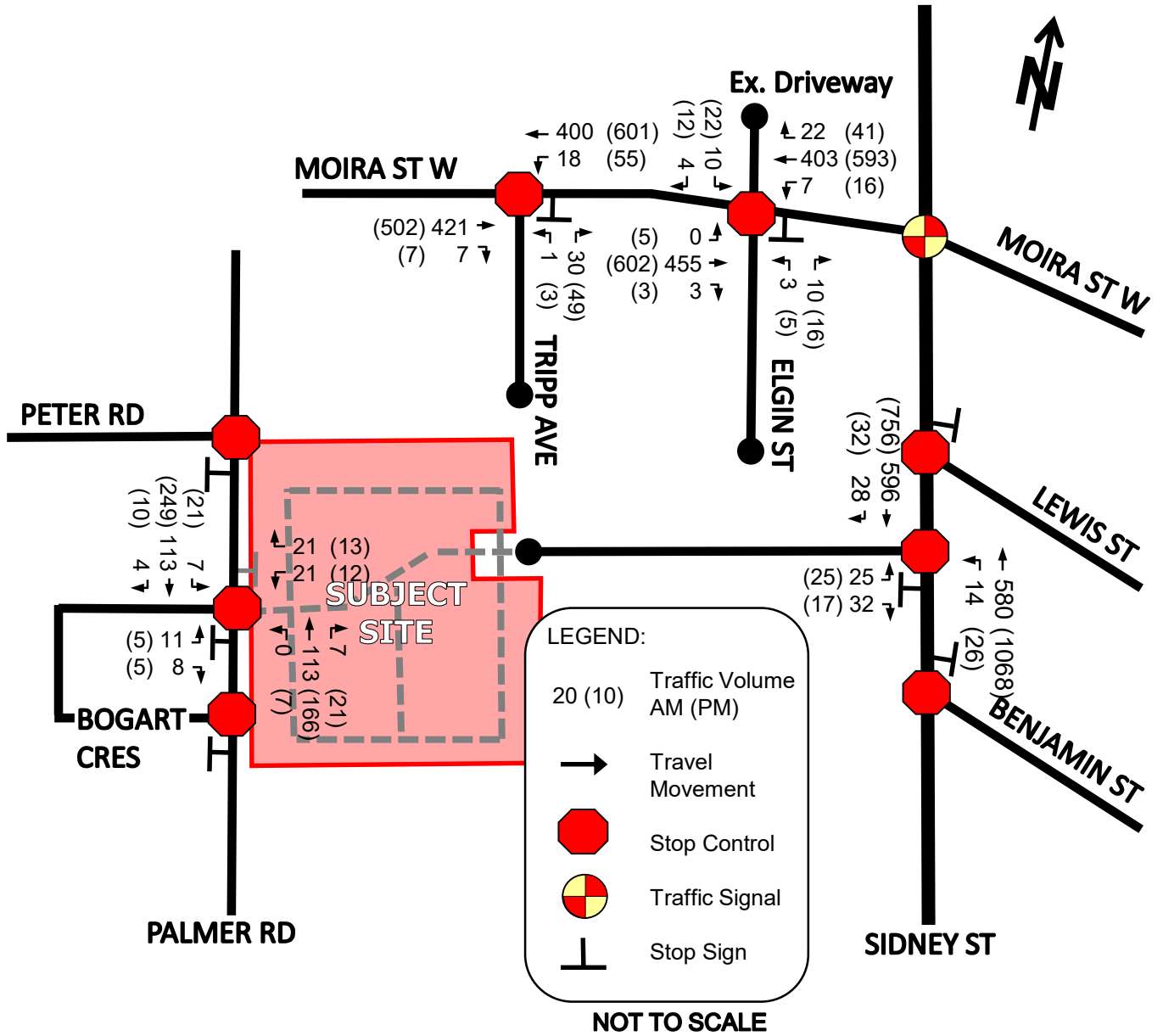

Figure 12: Total (2034) Traffic Volumes



Appendix A – Draft Plan of Subdivision



PART 3 21R-22517
PIN 40457-0231

LOT 5 PLAN 1819
PIN 40457-0156

PART 2 21R-22517
PIN 40457-0233

PART 1 21R-22886
PIN 40457-0240

PART 1 21R-22223
PIN 40457-0246

PIN 40457-0122

PIN 40457-0124

PIN 40457-0125

Existing Residential (R4)

PART 1 21R-18798

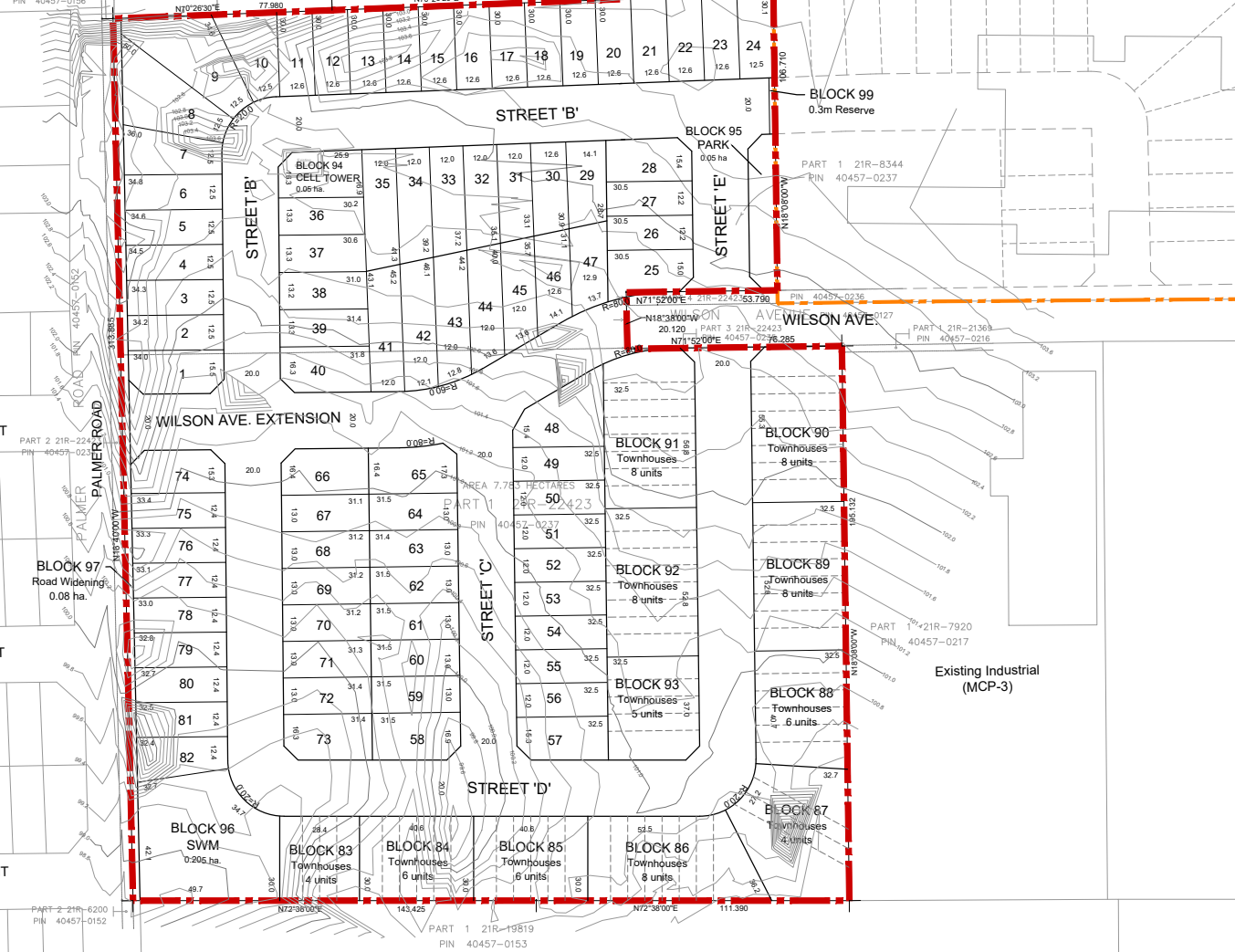

KEY MAP Scale: 1:10,000

SUBJECT LANDS
 ADDITIONAL LANDS OWNED BY APPLICANT

DRAFT PLAN OF SUBDIVISION

Part of Lots 15, 16, 17, 26 & 27, Plan 135,
Part of Lots 6 & 7, Plan 1819
in the City of Belleville,
County of Hastings

Scale
0 15 30 45 60 75m

LEGEND

SUBJECT SITE
 ADDITIONAL LANDS OWNED BY APPLICANT

OWNER'S CERTIFICATE

I HEREBY AUTHORIZE INNOVATIVE PLANNING SOLUTIONS TO PREPARE THIS DRAFT PLAN OF SUBDIVISION AND SUBMIT THIS DRAFT PLAN OF SUBDIVISION FOR APPROVAL.

DATE _____

RIC (MIDLAND LAND) INC.

SURVEYOR'S CERTIFICATE

I CERTIFY THAT THE BOUNDARIES OF THE LAND TO BE SUBDIVIDED AND THEIR RELATIONSHIP TO ADJACENT LANDS ARE ACCURATELY AND CORRECTLY SHOWN.

DATE _____

KEITH WATSON, ONTARIO LAND SURVEYOR
WATSON LAND SURVEYORS LTD.

ADDITIONAL INFORMATION REQUIRED UNDER SECTION 51(17) OF THE PLANNING ACT

A) SEE SURVEYOR'S CERTIFICATE
 B) AS SHOWN ON PLAN
 C) AS SHOWN ON KEY PLAN
 D) SEE LOTTING SUMMARY
 E) AS SHOWN ON PLAN
 F) AS SHOWN ON PLAN
 G) AS SHOWN ON PLAN
 H) FULL MUNICIPAL SERVICE
 I) AS SHOWN ON PLAN
 J) AS SHOWN ON PLAN
 K) FULL MUNICIPAL SERVICES
 L) AS SHOWN ON PLAN

LAND USE STATISTICS

LAND USE	LOT / BLK. NO.	UNITS	AREA (ha)
Single Detached Lots (R4 - 12m / 371.5m ²)	1-82	82	3.60
Street Townhouse Units (R5 - 5.1m)	83-93	71	1.63
Cell Tower	94		0.05
Park	95		0.05
SWM Facilities	96		0.21
Road Widening	97		0.08
0.3m Reserves	98		0.00
20.0m ROW			2.17
TOTAL		153	7.78

Street Length (Wilson Ave Extension, Street B-E) = 1,071.5m

SCHEDULE OF REVISIONS

No.	Date	Description	By
1	June 1, 2022	Updated Legal description and OLS boundary	BH

METRIC NOTE: DISTANCES SHOWN ON THIS PLAN ARE IN METRES AND CAN BE CONVERTED TO FEET BY DIVIDING BY 0.3048

IPS INNOVATIVE PLANNING SOLUTIONS
 PLANNERS • PROJECT MANAGERS • LAND DEVELOPERS
 647 WELSHAM RD., UNIT 5, BARRIE, ONTARIO, L4N 0B7
 Tel: 705-812-3281 Fax: 705-812-3438 e: info@innovativegps.com www.innovativegps.com

Date: December 14, 2020 **Drawn By:** BH
File: 20-908 **Checked:** KT

Appendix B – Adjacent Development Excerpts

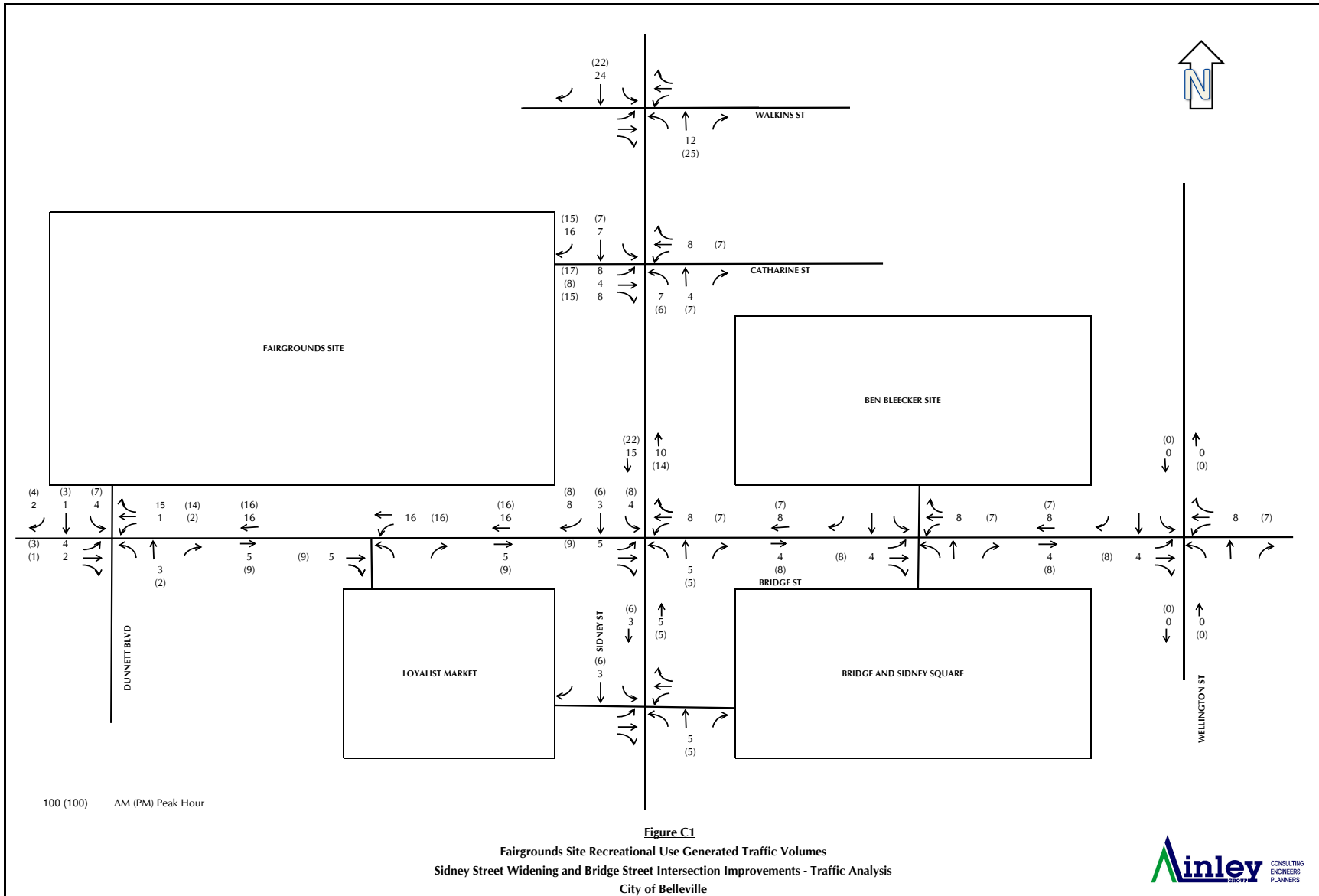

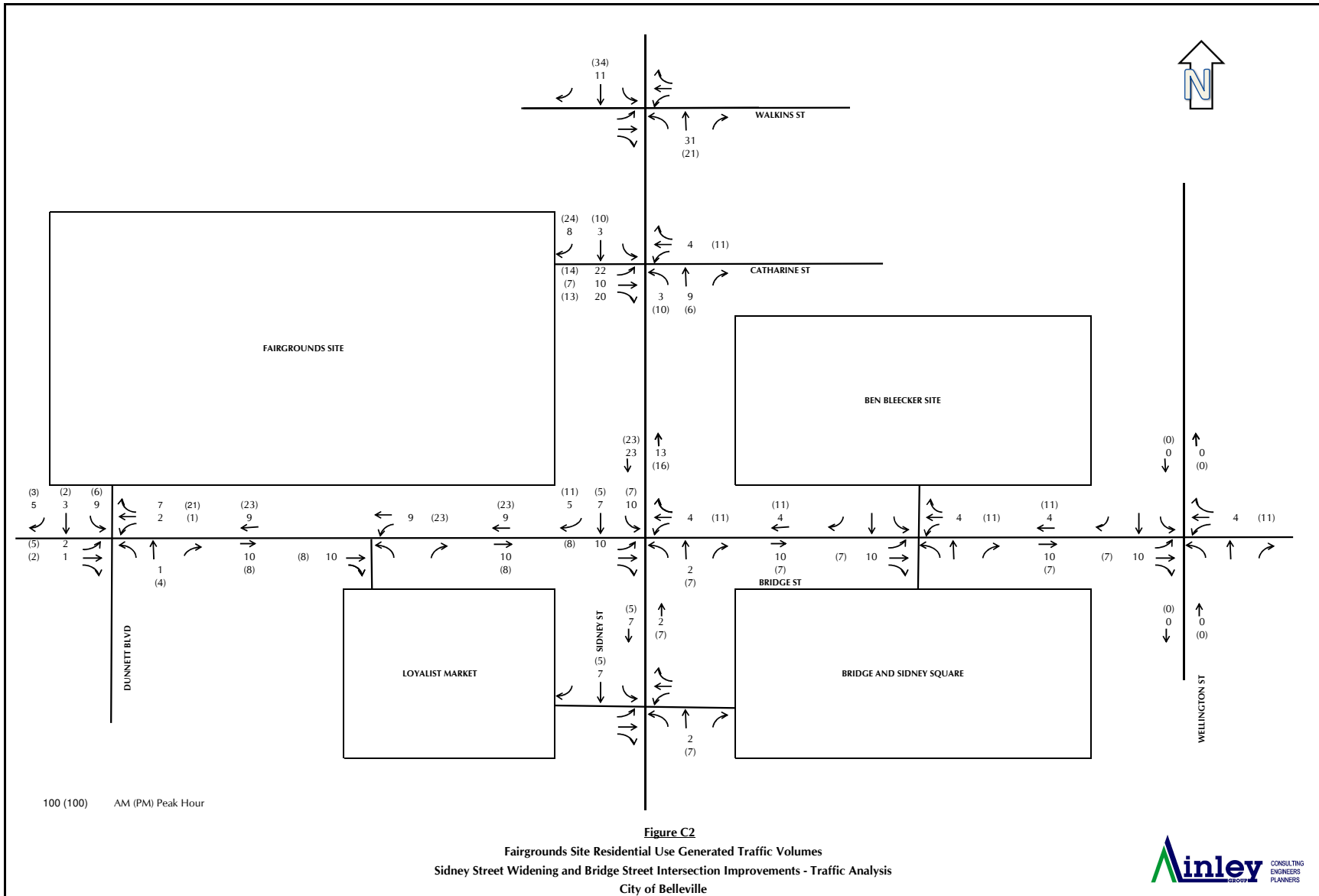

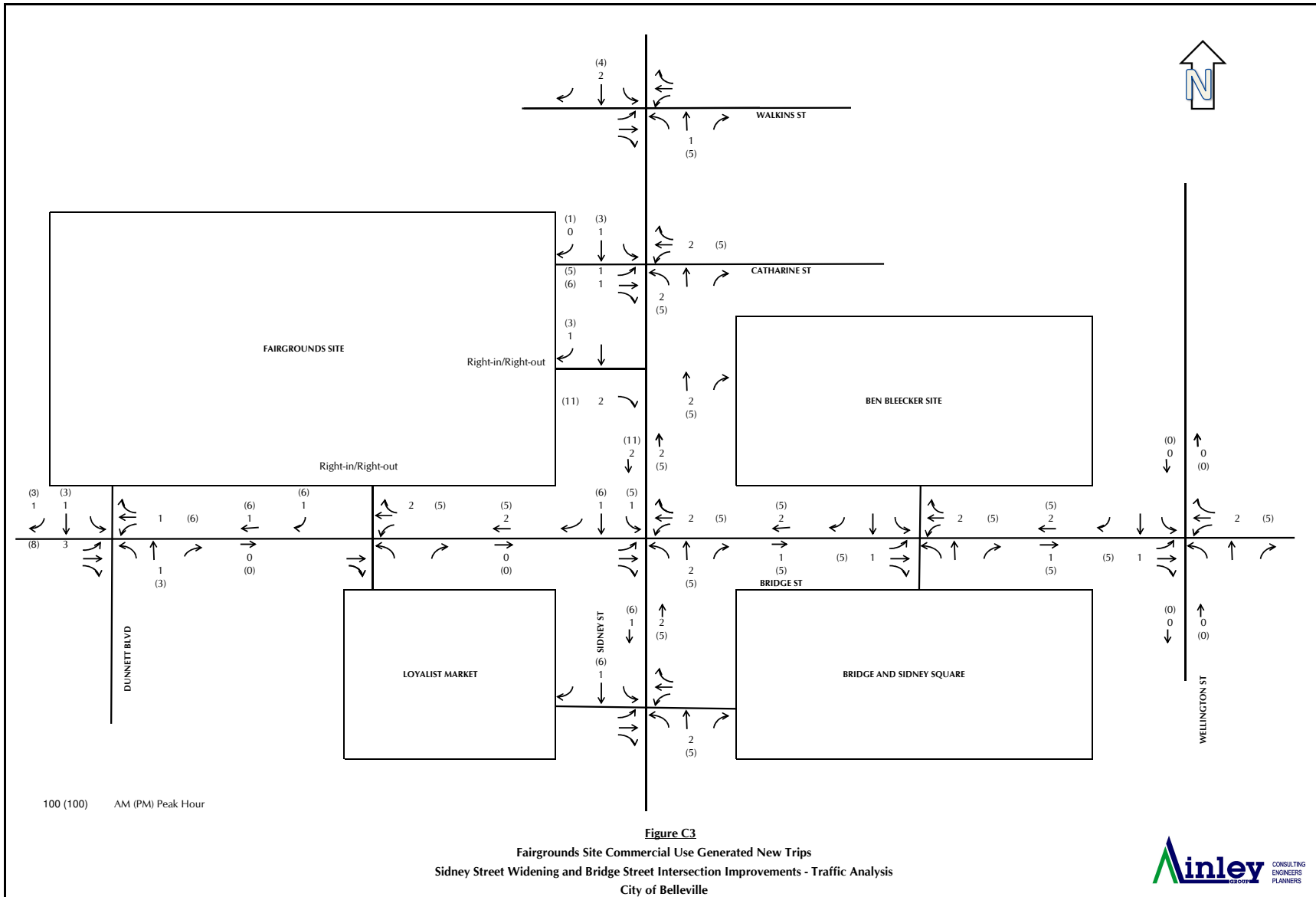

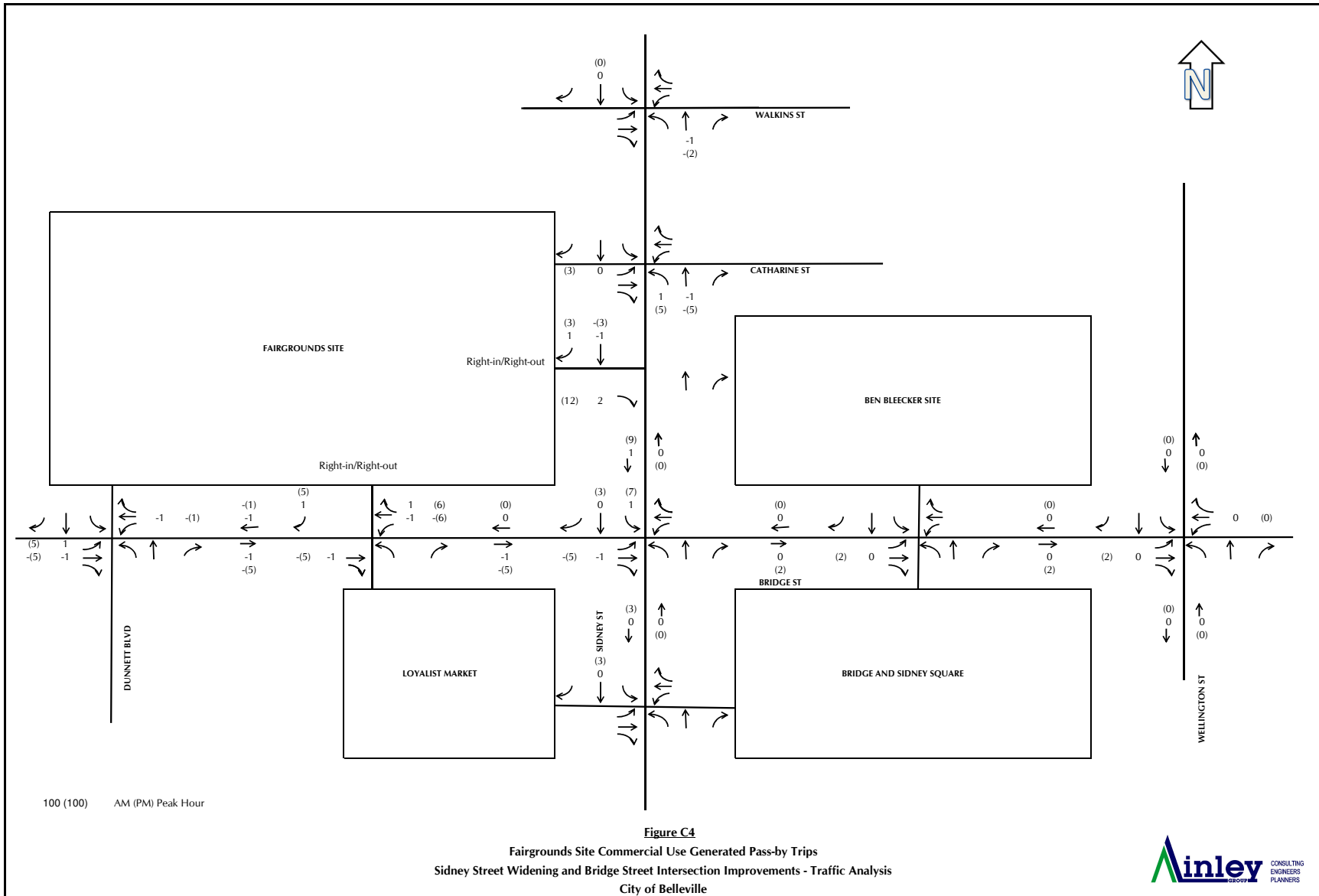

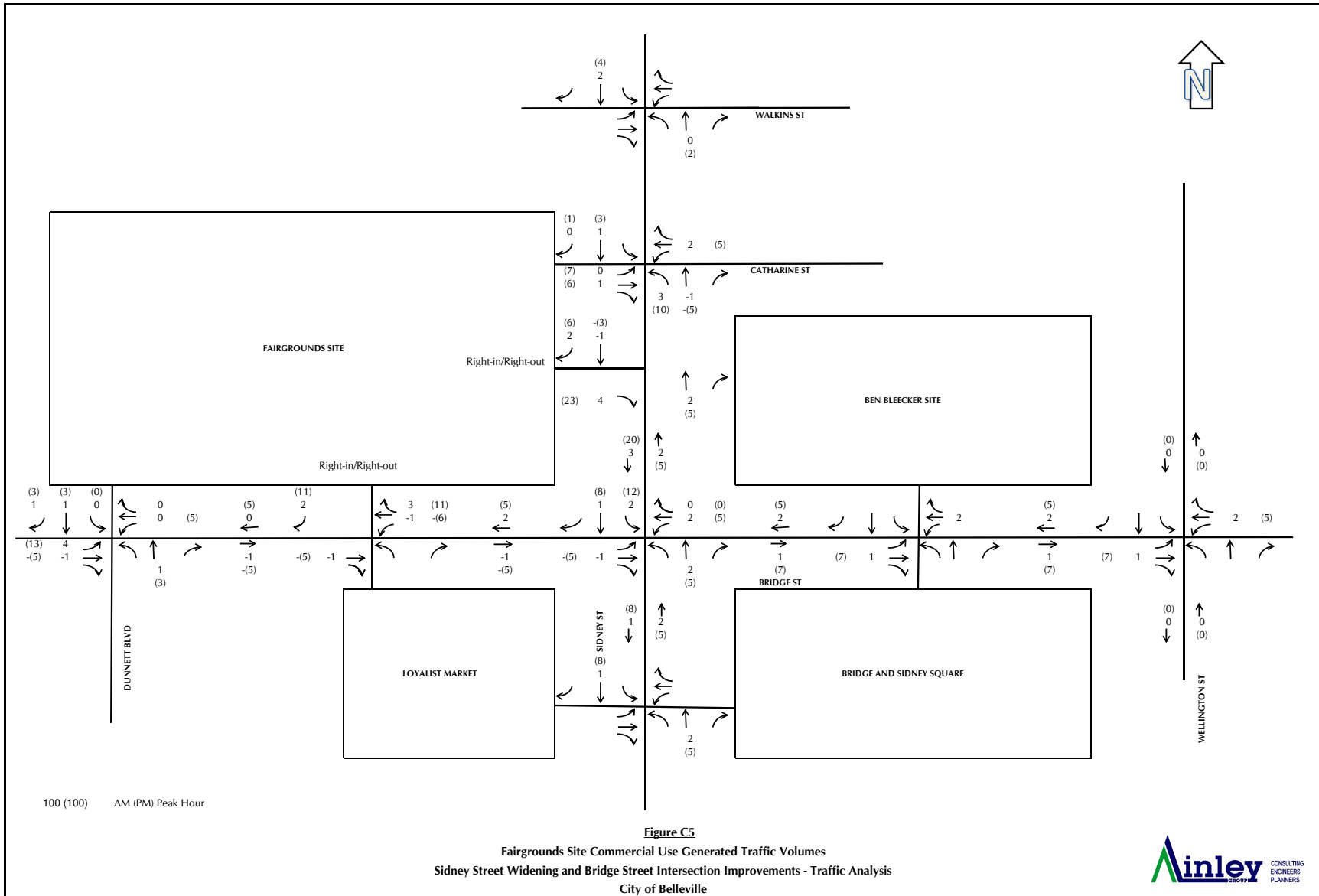

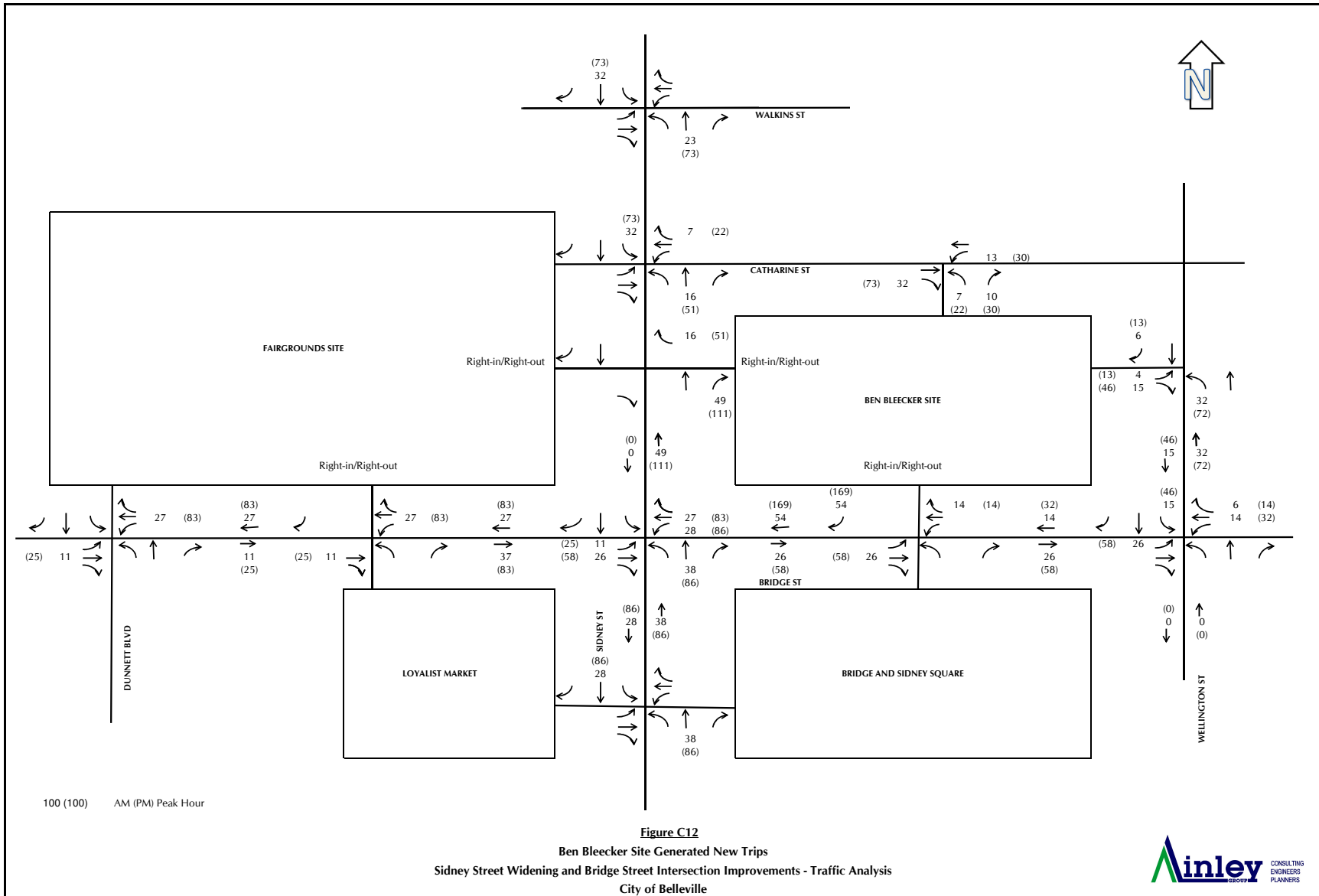

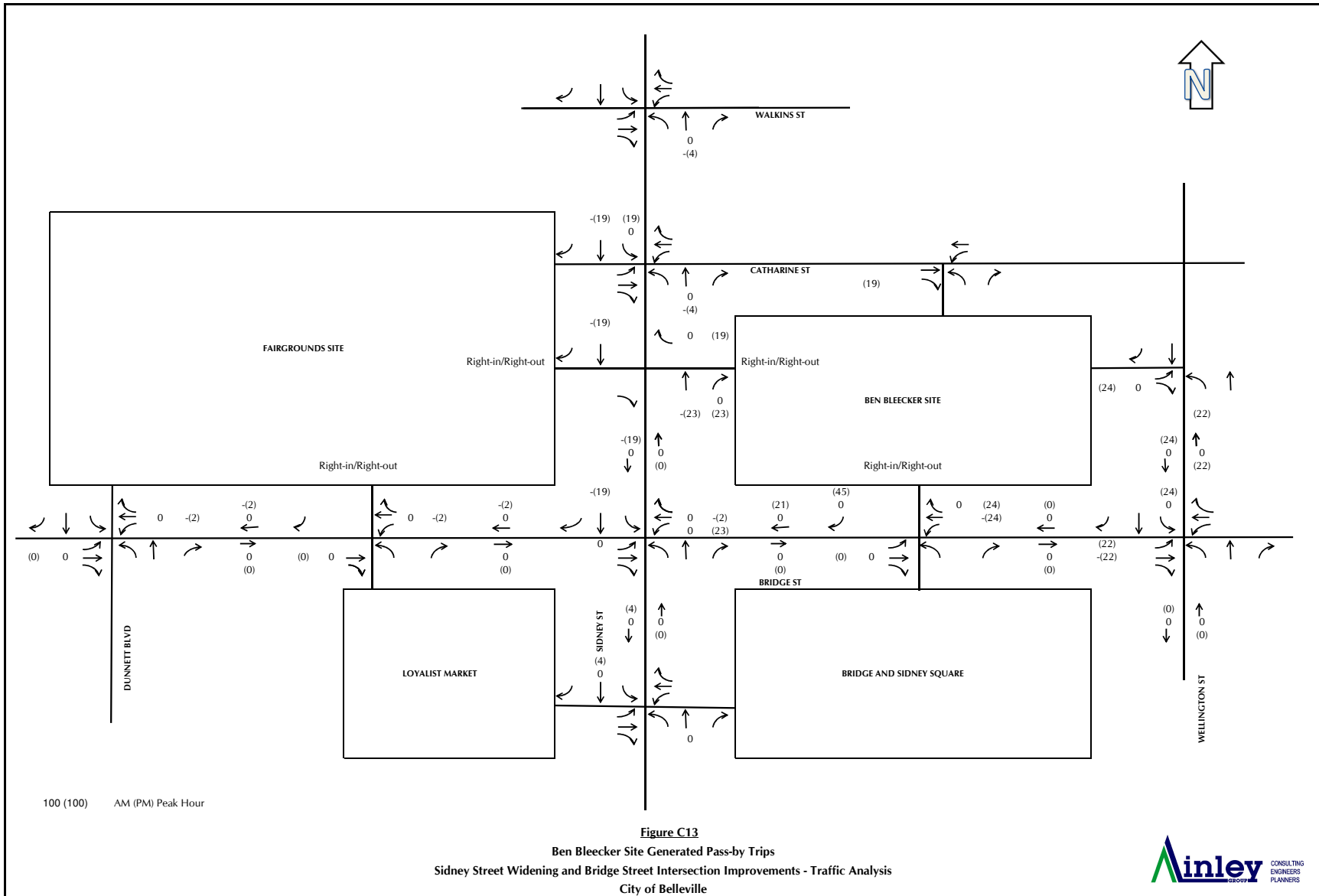

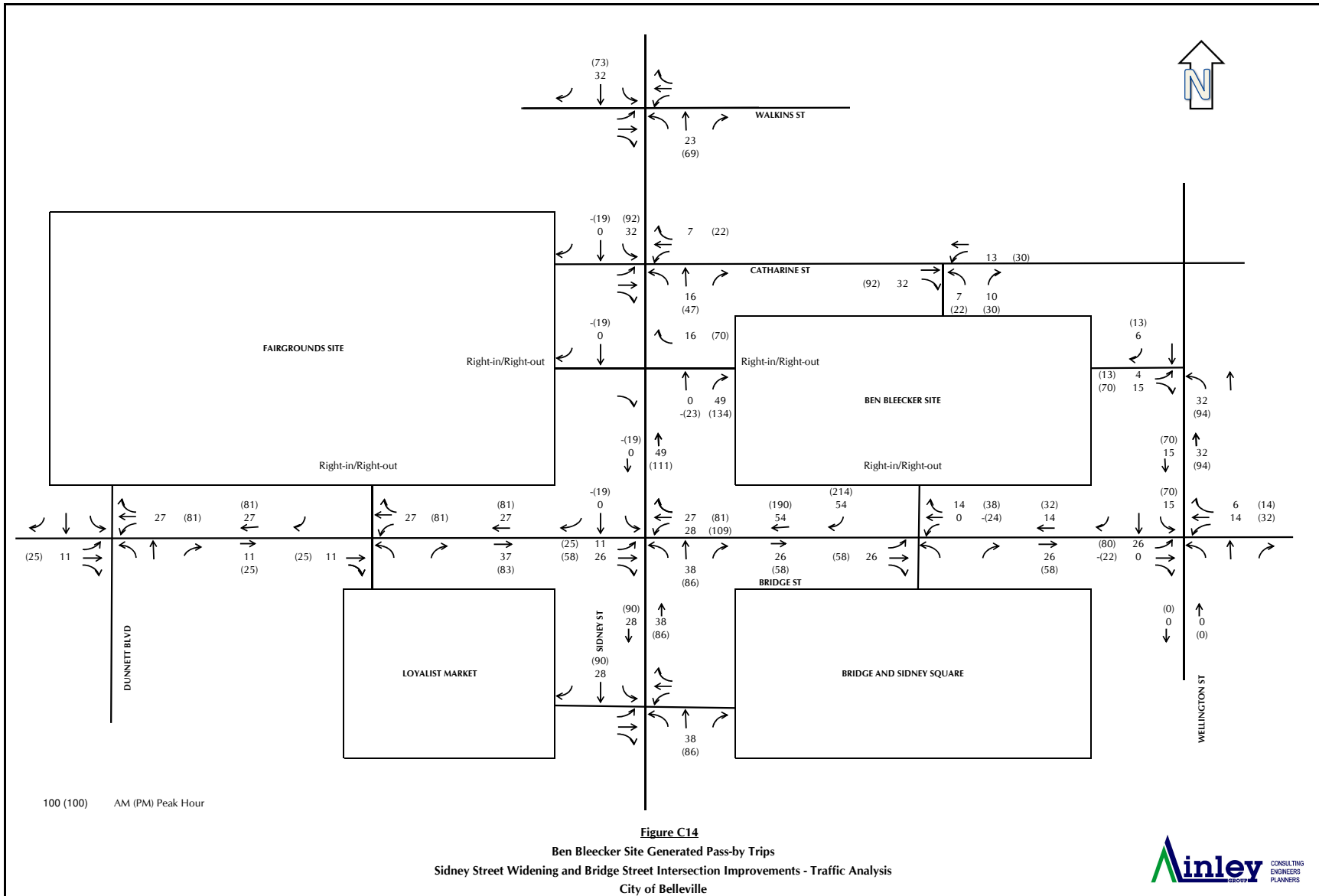



Appendix C – Traffic Count Data

Accu-Traffic Inc.

Morning Peak Diagram	Specified Period From: 7:00:00 To: 9:00:00	One Hour Peak From: 7:45:00 To: 8:45:00
-----------------------------	---	--

Municipality: Belleville Site #: 2104900005 Intersection: Sydney St & TFR File #: 1 Count date: 22-Jun-21	Weather conditions: Person counted: Person prepared: Person checked:
--	---

** Non-Signalized Intersection **	Major Road: Sydney St runs N/S
--	---------------------------------------

North Leg Total: 590 North Entering: 259 North Peds: 0 Peds Cross: \boxtimes	<table style="border-collapse: collapse;"> <tr><td>Heavys</td><td>0</td><td>9</td><td>0</td><td style="border-left: 1px solid black;">9</td></tr> <tr><td>Trucks</td><td>0</td><td>6</td><td>0</td><td style="border-left: 1px solid black;">6</td></tr> <tr><td>Cars</td><td>0</td><td>244</td><td>0</td><td style="border-left: 1px solid black;">244</td></tr> <tr><td>Totals</td><td>0</td><td>259</td><td>0</td><td style="border-left: 1px solid black;"></td></tr> </table>	Heavys	0	9	0	9	Trucks	0	6	0	6	Cars	0	244	0	244	Totals	0	259	0			<table style="border-collapse: collapse;"> <tr><td>Heavys</td><td>15</td></tr> <tr><td>Trucks</td><td>0</td></tr> <tr><td>Cars</td><td>316</td></tr> <tr><td>Totals</td><td>331</td></tr> </table>	Heavys	15	Trucks	0	Cars	316	Totals	331	East Leg Total: 0 East Entering: 0 East Peds: 3 Peds Cross: \boxtimes
Heavys	0	9	0	9																												
Trucks	0	6	0	6																												
Cars	0	244	0	244																												
Totals	0	259	0																													
Heavys	15																															
Trucks	0																															
Cars	316																															
Totals	331																															

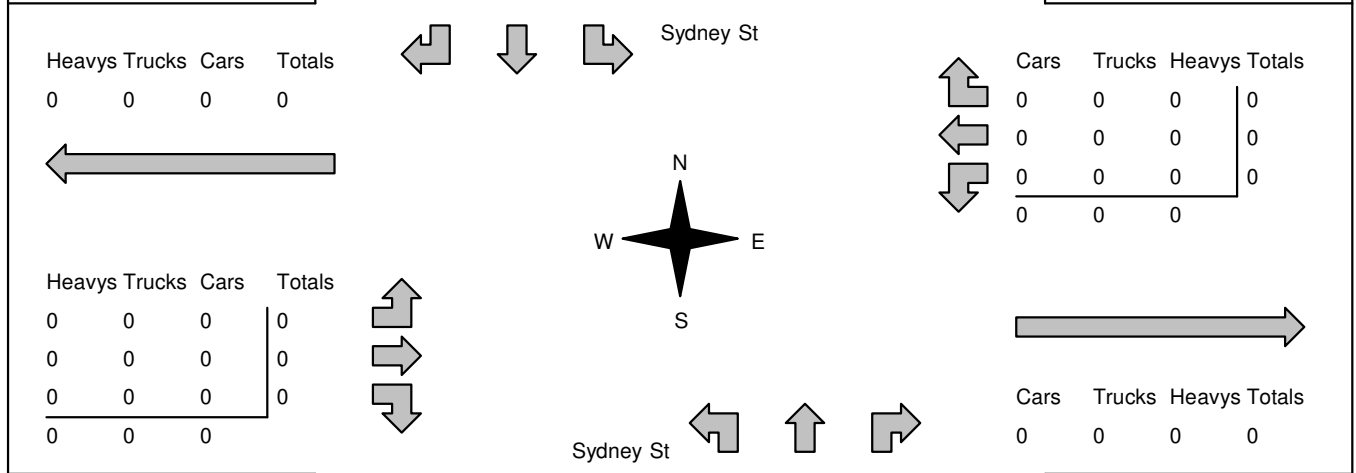

Peds Cross: \boxtimes West Peds: 1 West Entering: 0 West Leg Total: 0	<table style="border-collapse: collapse;"> <tr><td>Cars</td><td>244</td></tr> <tr><td>Trucks</td><td>6</td></tr> <tr><td>Heavys</td><td>9</td></tr> <tr><td>Totals</td><td>259</td></tr> </table>	Cars	244	Trucks	6	Heavys	9	Totals	259		<table style="border-collapse: collapse;"> <tr><td>Cars</td><td>0</td><td>316</td><td>0</td><td style="border-left: 1px solid black;">316</td></tr> <tr><td>Trucks</td><td>0</td><td>0</td><td>0</td><td style="border-left: 1px solid black;">0</td></tr> <tr><td>Heavys</td><td>0</td><td>15</td><td>0</td><td style="border-left: 1px solid black;">15</td></tr> <tr><td>Totals</td><td>0</td><td>331</td><td>0</td><td style="border-left: 1px solid black;"></td></tr> </table>	Cars	0	316	0	316	Trucks	0	0	0	0	Heavys	0	15	0	15	Totals	0	331	0		Peds Cross: \boxtimes South Peds: 0 South Entering: 331 South Leg Total: 590
Cars	244																															
Trucks	6																															
Heavys	9																															
Totals	259																															
Cars	0	316	0	316																												
Trucks	0	0	0	0																												
Heavys	0	15	0	15																												
Totals	0	331	0																													

Comments

Accu-Traffic Inc.

Afternoon Peak Diagram	Specified Period From: 16:00:00 To: 19:00:00	One Hour Peak From: 16:30:00 To: 17:30:00
-------------------------------	---	--

Municipality: Belleville Site #: 2104900005 Intersection: Sydney St & TFR File #: 1 Count date: 22-Jun-21	Weather conditions: Person counted: Person prepared: Person checked:
--	---

** Non-Signalized Intersection **	Major Road: Sydney St runs N/S
--	---------------------------------------

North Leg Total: 936 North Entering: 416 North Peds: 0 Peds Cross: \times	<table style="margin: auto;"> <tr><td>Heavys</td><td>0</td><td>6</td><td>0</td><td>6</td></tr> <tr><td>Trucks</td><td>0</td><td>2</td><td>0</td><td>2</td></tr> <tr><td>Cars</td><td>0</td><td>408</td><td>0</td><td>408</td></tr> <tr style="border-top: 1px solid black;"><td>Totals</td><td>0</td><td>416</td><td>0</td><td>408</td></tr> </table>	Heavys	0	6	0	6	Trucks	0	2	0	2	Cars	0	408	0	408	Totals	0	416	0	408	<table style="margin: auto;"> <tr><td>Heavys</td><td>5</td></tr> <tr><td>Trucks</td><td>8</td></tr> <tr><td>Cars</td><td>507</td></tr> <tr style="border-top: 1px solid black;"><td>Totals</td><td>520</td></tr> </table>	Heavys	5	Trucks	8	Cars	507	Totals	520	East Leg Total: 0 East Entering: 0 East Peds: 8 Peds Cross: \times
Heavys	0	6	0	6																											
Trucks	0	2	0	2																											
Cars	0	408	0	408																											
Totals	0	416	0	408																											
Heavys	5																														
Trucks	8																														
Cars	507																														
Totals	520																														

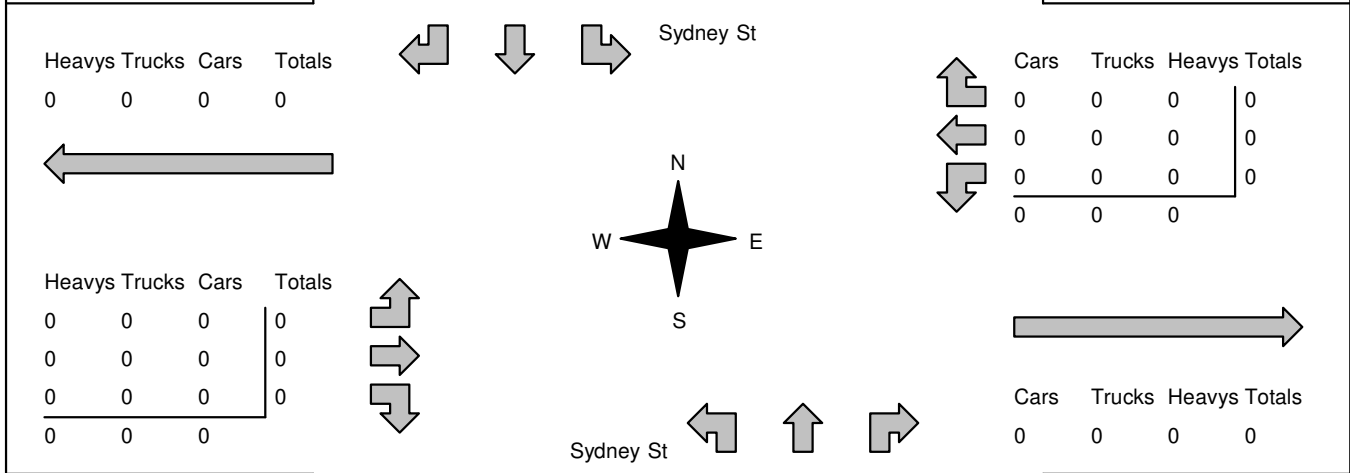

Peds Cross: \times West Peds: 0 West Entering: 0 West Leg Total: 0	<table style="margin: auto;"> <tr><td>Cars</td><td>408</td></tr> <tr><td>Trucks</td><td>2</td></tr> <tr><td>Heavys</td><td>6</td></tr> <tr style="border-top: 1px solid black;"><td>Totals</td><td>416</td></tr> </table>	Cars	408	Trucks	2	Heavys	6	Totals	416	<table style="margin: auto;"> <tr><td>Cars</td><td>0</td><td>507</td><td>0</td><td>507</td></tr> <tr><td>Trucks</td><td>0</td><td>8</td><td>0</td><td>8</td></tr> <tr><td>Heavys</td><td>0</td><td>5</td><td>0</td><td>5</td></tr> <tr style="border-top: 1px solid black;"><td>Totals</td><td>0</td><td>520</td><td>0</td><td>520</td></tr> </table>	Cars	0	507	0	507	Trucks	0	8	0	8	Heavys	0	5	0	5	Totals	0	520	0	520	Peds Cross: \times South Peds: 0 South Entering: 520 South Leg Total: 936
Cars	408																														
Trucks	2																														
Heavys	6																														
Totals	416																														
Cars	0	507	0	507																											
Trucks	0	8	0	8																											
Heavys	0	5	0	5																											
Totals	0	520	0	520																											

Comments

Accu-Traffic Inc.

Morning Peak Diagram	Specified Period From: 7:00:00 To: 9:00:00	One Hour Peak From: 8:00:00 To: 9:00:00
-----------------------------	---	--

Municipality: Belleville Site #: 2104900001 Intersection: Sydney St & Wilson Ave TFR File #: 1 Count date: 22-Jun-21	Weather conditions: Person counted: Person prepared: Person checked:
---	---

** Non-Signalized Intersection **	Major Road: Sydney St runs N/S
--	---------------------------------------

North Leg Total: 648 North Entering: 332 North Peds: 0 Peds Cross: \boxtimes	<table style="border-collapse: collapse;"> <tr><td>Heavys</td><td>1</td><td>10</td><td>0</td><td style="border-left: 1px solid black;">11</td></tr> <tr><td>Trucks</td><td>0</td><td>8</td><td>0</td><td style="border-left: 1px solid black;">8</td></tr> <tr><td>Cars</td><td>14</td><td>297</td><td>2</td><td style="border-left: 1px solid black;">313</td></tr> <tr><td>Totals</td><td>15</td><td>315</td><td>2</td><td style="border-left: 1px solid black;"></td></tr> </table>	Heavys	1	10	0	11	Trucks	0	8	0	8	Cars	14	297	2	313	Totals	15	315	2			<table style="border-collapse: collapse;"> <tr><td>Heavys</td><td>16</td></tr> <tr><td>Trucks</td><td>2</td></tr> <tr><td>Cars</td><td>298</td></tr> <tr><td>Totals</td><td>316</td></tr> </table>	Heavys	16	Trucks	2	Cars	298	Totals	316	East Leg Total: 10 East Entering: 7 East Peds: 7 Peds Cross: \boxtimes
Heavys	1	10	0	11																												
Trucks	0	8	0	8																												
Cars	14	297	2	313																												
Totals	15	315	2																													
Heavys	16																															
Trucks	2																															
Cars	298																															
Totals	316																															

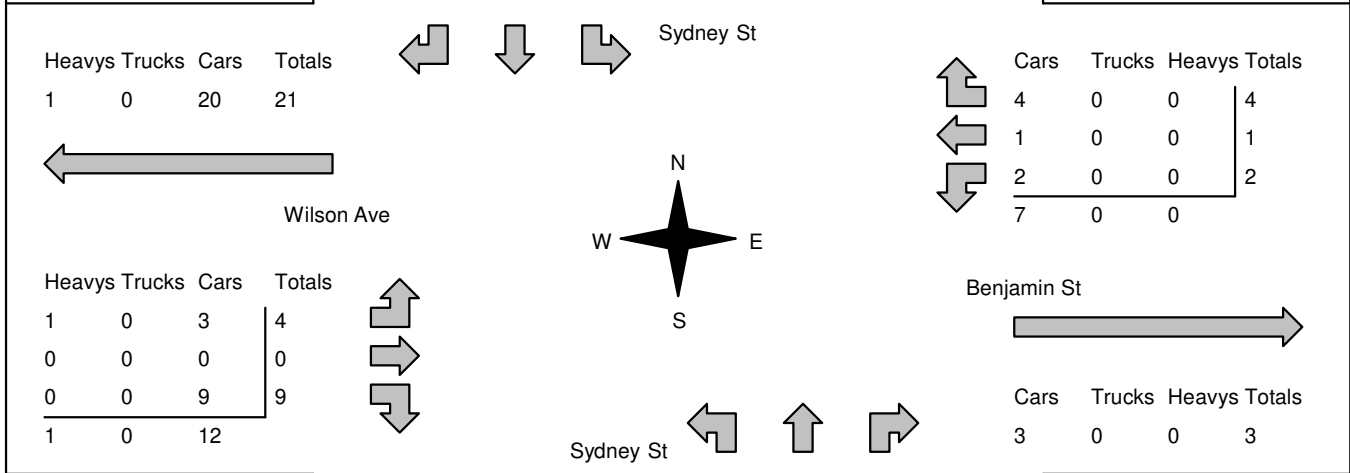

Peds Cross: \boxtimes West Peds: 6 West Entering: 13 West Leg Total: 34	<table style="border-collapse: collapse;"> <tr><td>Cars</td><td>308</td></tr> <tr><td>Trucks</td><td>8</td></tr> <tr><td>Heavys</td><td>10</td></tr> <tr><td>Totals</td><td>326</td></tr> </table>	Cars	308	Trucks	8	Heavys	10	Totals	326		<table style="border-collapse: collapse;"> <tr><td>Cars</td><td>5</td><td>291</td><td>1</td><td style="border-left: 1px solid black;">297</td></tr> <tr><td>Trucks</td><td>0</td><td>2</td><td>0</td><td style="border-left: 1px solid black;">2</td></tr> <tr><td>Heavys</td><td>0</td><td>15</td><td>0</td><td style="border-left: 1px solid black;">15</td></tr> <tr><td>Totals</td><td>5</td><td>308</td><td>1</td><td style="border-left: 1px solid black;"></td></tr> </table>	Cars	5	291	1	297	Trucks	0	2	0	2	Heavys	0	15	0	15	Totals	5	308	1		Peds Cross: \boxtimes South Peds: 0 South Entering: 314 South Leg Total: 640
Cars	308																															
Trucks	8																															
Heavys	10																															
Totals	326																															
Cars	5	291	1	297																												
Trucks	0	2	0	2																												
Heavys	0	15	0	15																												
Totals	5	308	1																													

Comments

Accu-Traffic Inc.

Afternoon Peak Diagram	Specified Period From: 16:00:00 To: 19:00:00	One Hour Peak From: 16:00:00 To: 17:00:00
-------------------------------	---	--

Municipality: Belleville Site #: 2104900001 Intersection: Sydney St & Wilson Ave TFR File #: 1 Count date: 22-Jun-21	Weather conditions: Person counted: Person prepared: Person checked:
---	---

** Non-Signalized Intersection **	Major Road: Sydney St runs N/S
--	---------------------------------------

North Leg Total: 979 North Entering: 390 North Peds: 0 Peds Cross: \times	<table style="border-collapse: collapse; margin: auto;"> <tr><td>Heavys</td><td>0</td><td>8</td><td>0</td><td style="border-left: 1px solid black;">8</td></tr> <tr><td>Trucks</td><td>0</td><td>2</td><td>0</td><td style="border-left: 1px solid black;">2</td></tr> <tr><td>Cars</td><td>7</td><td>363</td><td>10</td><td style="border-left: 1px solid black;">380</td></tr> <tr><td>Totals</td><td>7</td><td>373</td><td>10</td><td style="border-left: 1px solid black;"></td></tr> </table>	Heavys	0	8	0	8	Trucks	0	2	0	2	Cars	7	363	10	380	Totals	7	373	10		<table style="border-collapse: collapse; margin: auto;"> <tr><td>Heavys</td><td>9</td></tr> <tr><td>Trucks</td><td>5</td></tr> <tr><td>Cars</td><td>575</td></tr> <tr><td>Totals</td><td>589</td></tr> </table>	Heavys	9	Trucks	5	Cars	575	Totals	589	East Leg Total: 26 East Entering: 13 East Peds: 10 Peds Cross: \times
Heavys	0	8	0	8																											
Trucks	0	2	0	2																											
Cars	7	363	10	380																											
Totals	7	373	10																												
Heavys	9																														
Trucks	5																														
Cars	575																														
Totals	589																														

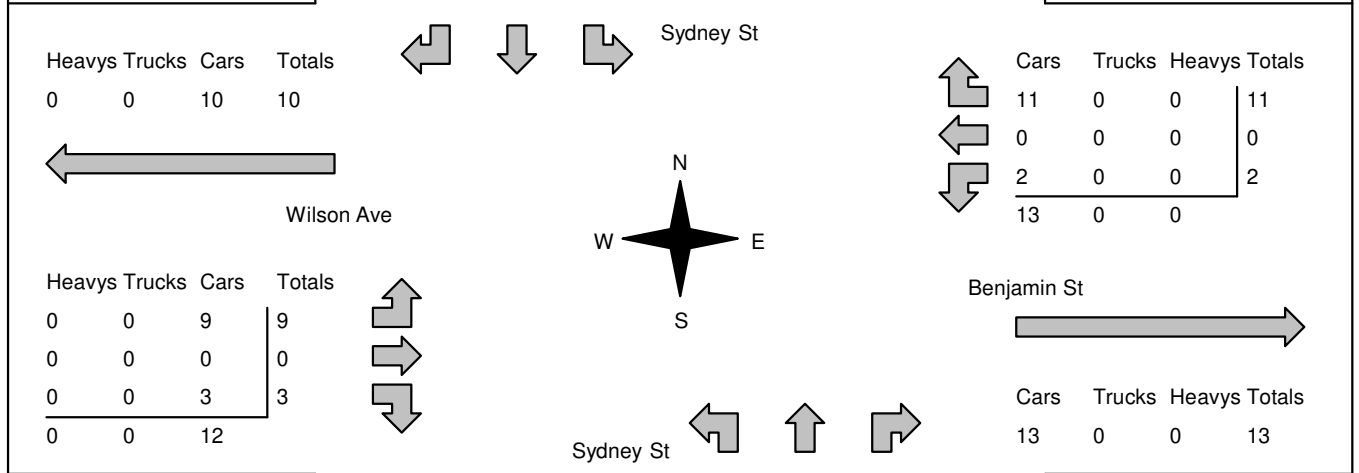

Peds Cross: \times West Peds: 0 West Entering: 12 West Leg Total: 22	<table style="border-collapse: collapse; margin: auto;"> <tr><td>Cars</td><td>368</td></tr> <tr><td>Trucks</td><td>2</td></tr> <tr><td>Heavys</td><td>8</td></tr> <tr><td>Totals</td><td>378</td></tr> </table>	Cars	368	Trucks	2	Heavys	8	Totals	378	<table style="border-collapse: collapse; margin: auto;"> <tr><td>Cars</td><td>3</td><td>555</td><td>3</td><td style="border-left: 1px solid black;">561</td></tr> <tr><td>Trucks</td><td>0</td><td>5</td><td>0</td><td style="border-left: 1px solid black;">5</td></tr> <tr><td>Heavys</td><td>0</td><td>9</td><td>0</td><td style="border-left: 1px solid black;">9</td></tr> <tr><td>Totals</td><td>3</td><td>569</td><td>3</td><td style="border-left: 1px solid black;"></td></tr> </table>	Cars	3	555	3	561	Trucks	0	5	0	5	Heavys	0	9	0	9	Totals	3	569	3		Peds Cross: \times South Peds: 0 South Entering: 575 South Leg Total: 953
Cars	368																														
Trucks	2																														
Heavys	8																														
Totals	378																														
Cars	3	555	3	561																											
Trucks	0	5	0	5																											
Heavys	0	9	0	9																											
Totals	3	569	3																												

Comments

Accu-Traffic Inc.

Morning Peak Diagram

Specified Period

From: 7:00:00
To: 9:00:00

One Hour Peak

From: 7:30:00
To: 8:30:00

Municipality: Belleville
Site #: 2104900002
Intersection: Palmer Rd & Bogart Cres
TFR File #: 1
Count date: 22-Jun-21

Weather conditions:

Person counted:
Person prepared:
Person checked:

** Non-Signalized Intersection **

Major Road: Palmer Rd runs N/S

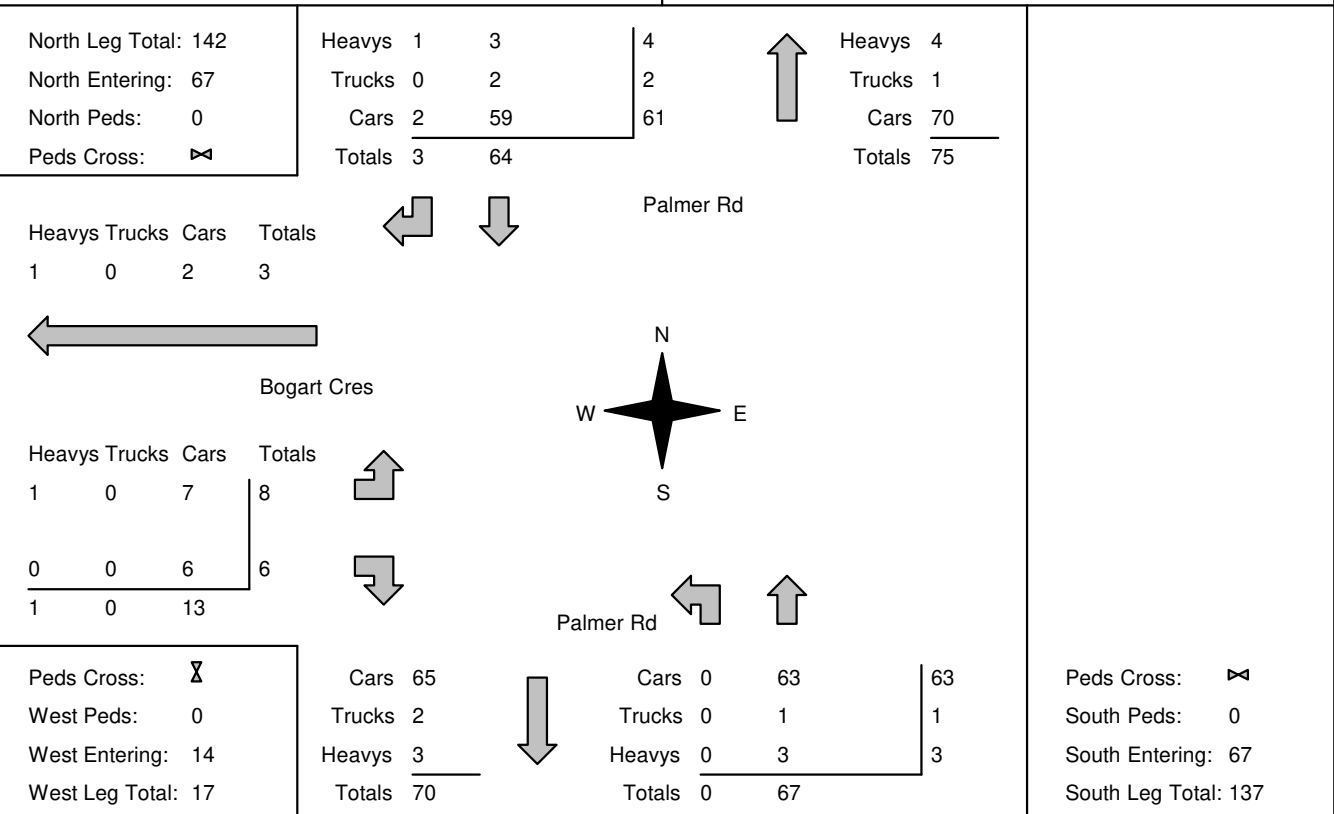

Comments

Accu-Traffic Inc.

Afternoon Peak Diagram

Specified Period

From: 16:00:00

To: 19:00:00

One Hour Peak

From: 16:15:00

To: 17:15:00

Municipality: Belleville
Site #: 2104900002
Intersection: Palmer Rd & Bogart Cres
TFR File #: 1
Count date: 22-Jun-21

Weather conditions:

Person counted:
Person prepared:
Person checked:

** Non-Signalized Intersection **

Major Road: Palmer Rd runs N/S

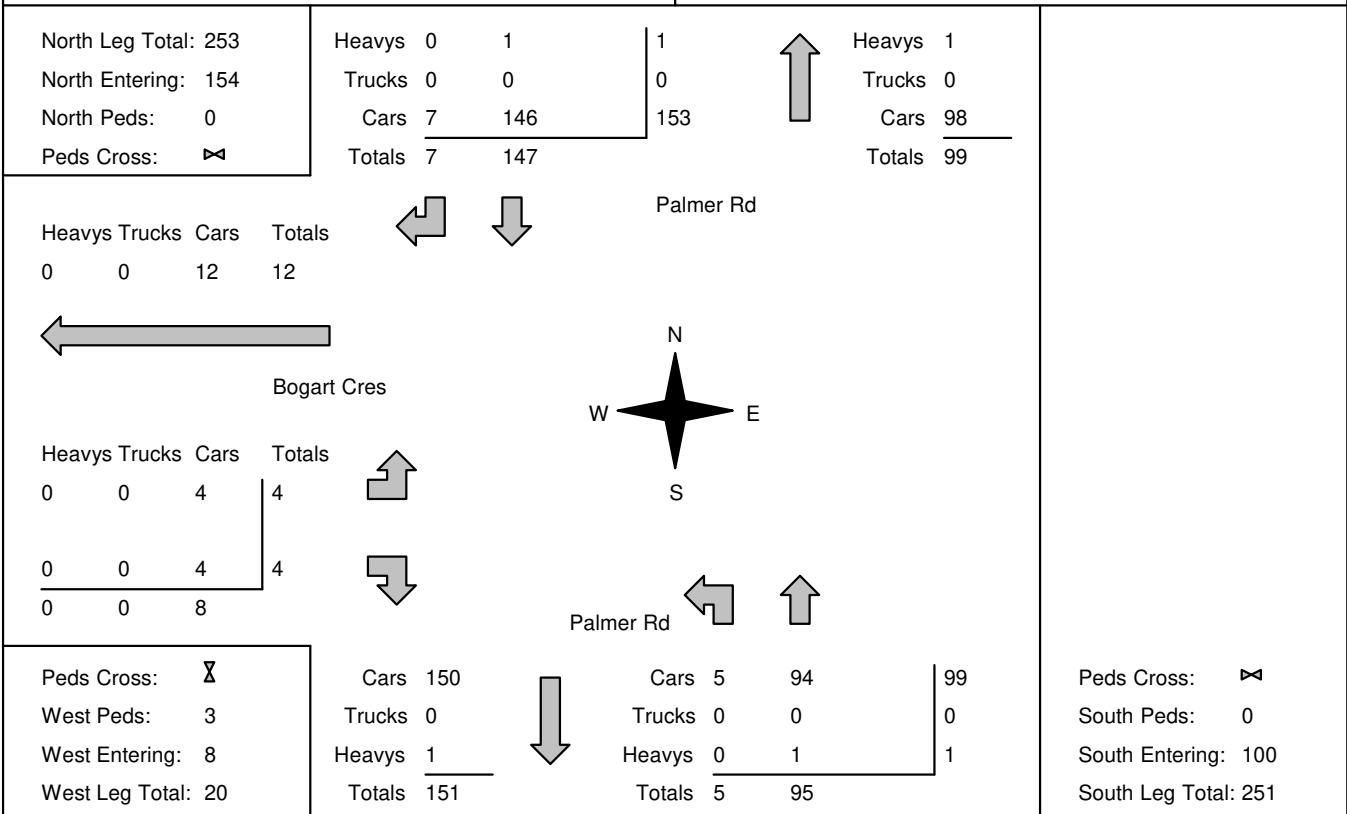

Comments

Accu-Traffic Inc.

Morning Peak Diagram	Specified Period From: 7:00:00 To: 9:00:00	One Hour Peak From: 7:30:00 To: 8:30:00
Municipality: Belleville Site #: 2104900003 Intersection: Moira St W & Tripp Ave TFR File #: 1 Count date: 22-Jun-21	Weather conditions: Person counted: Person prepared: Person checked:	
** Non-Signalized Intersection **	Major Road: Moira St W runs W/E	

East Leg Total: 506
East Entering: 245
East Peds: 1
Peds Cross: 8

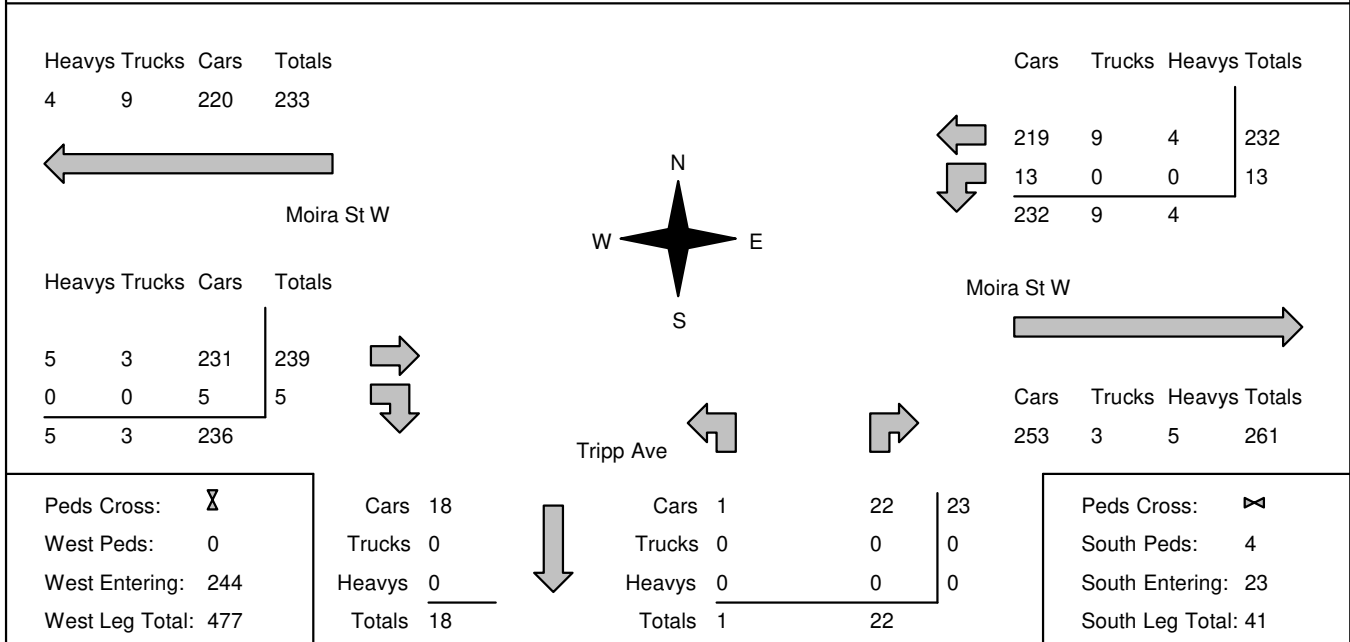

Comments

Accu-Traffic Inc.

Afternoon Peak Diagram	Specified Period From: 16:00:00 To: 19:00:00	One Hour Peak From: 16:30:00 To: 17:30:00
Municipality: Belleville Site #: 2104900003 Intersection: Moira St W & Tripp Ave TFR File #: 1 Count date: 22-Jun-21	Weather conditions: Person counted: Person prepared: Person checked:	
** Non-Signalized Intersection **	Major Road: Moira St W runs W/E	

	East Leg Total: 704 East Entering: 383 East Peds: 1 Peds Cross: 8
--	--

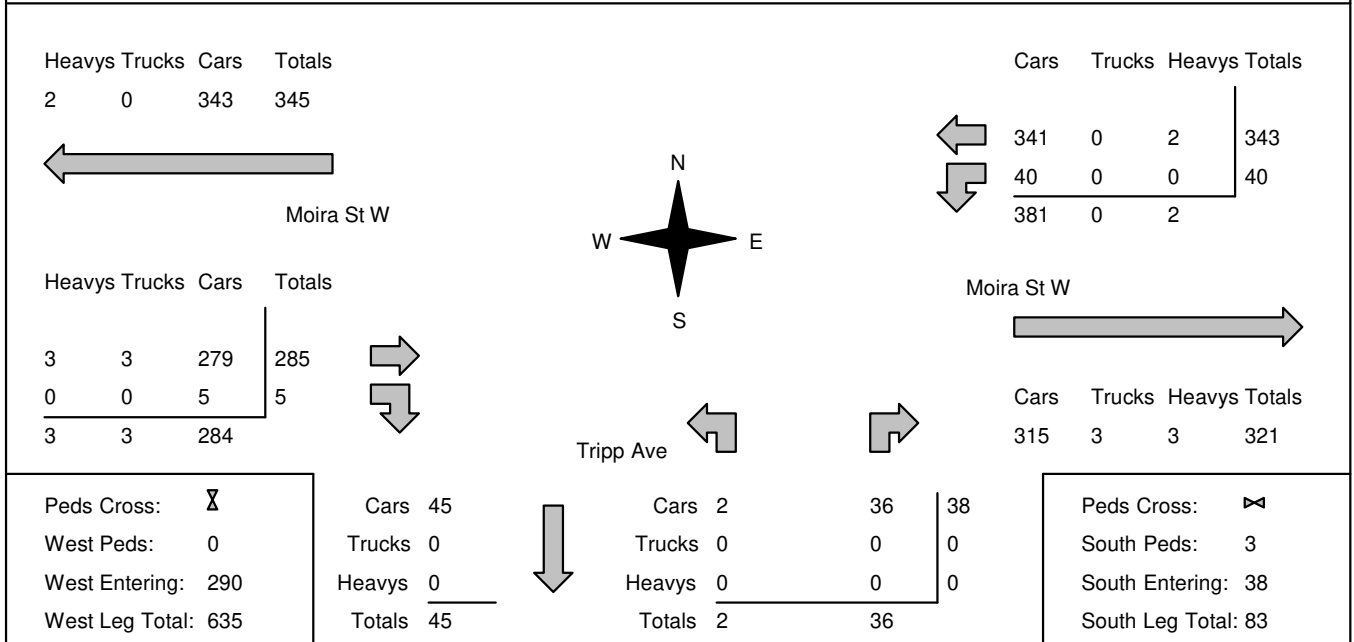

Comments

Accu-Traffic Inc.

Morning Peak Diagram	Specified Period From: 7:00:00 To: 9:00:00	One Hour Peak From: 7:30:00 To: 8:30:00
-----------------------------	---	--

Municipality: Belleville Site #: 2104900004 Intersection: Moira St W & Elgin St TFR File #: 1 Count date: 22-Jun-21	Weather conditions: Person counted: Person prepared: Person checked:
--	---

** Non-Signalized Intersection **	Major Road: Moira St W runs W/E
--	--

North Leg Total: 26 North Entering: 10 North Peds: 2 Peds Cross: ☒	<table style="border-collapse: collapse;"> <tr><td>Heavys</td><td>0</td><td>0</td><td>0</td><td>0</td></tr> <tr><td>Trucks</td><td>0</td><td>0</td><td>0</td><td>0</td></tr> <tr><td>Cars</td><td>3</td><td>0</td><td>7</td><td>10</td></tr> <tr style="border-top: 1px solid black;"><td>Totals</td><td>3</td><td>0</td><td>7</td><td></td></tr> </table>	Heavys	0	0	0	0	Trucks	0	0	0	0	Cars	3	0	7	10	Totals	3	0	7		↑	<table style="border-collapse: collapse;"> <tr><td>Heavys</td><td>0</td></tr> <tr><td>Trucks</td><td>0</td></tr> <tr><td>Cars</td><td>16</td></tr> <tr style="border-top: 1px solid black;"><td>Totals</td><td>16</td></tr> </table>	Heavys	0	Trucks	0	Cars	16	Totals	16	East Leg Total: 528 East Entering: 255 East Peds: 3 Peds Cross: ☒
Heavys	0	0	0	0																												
Trucks	0	0	0	0																												
Cars	3	0	7	10																												
Totals	3	0	7																													
Heavys	0																															
Trucks	0																															
Cars	16																															
Totals	16																															

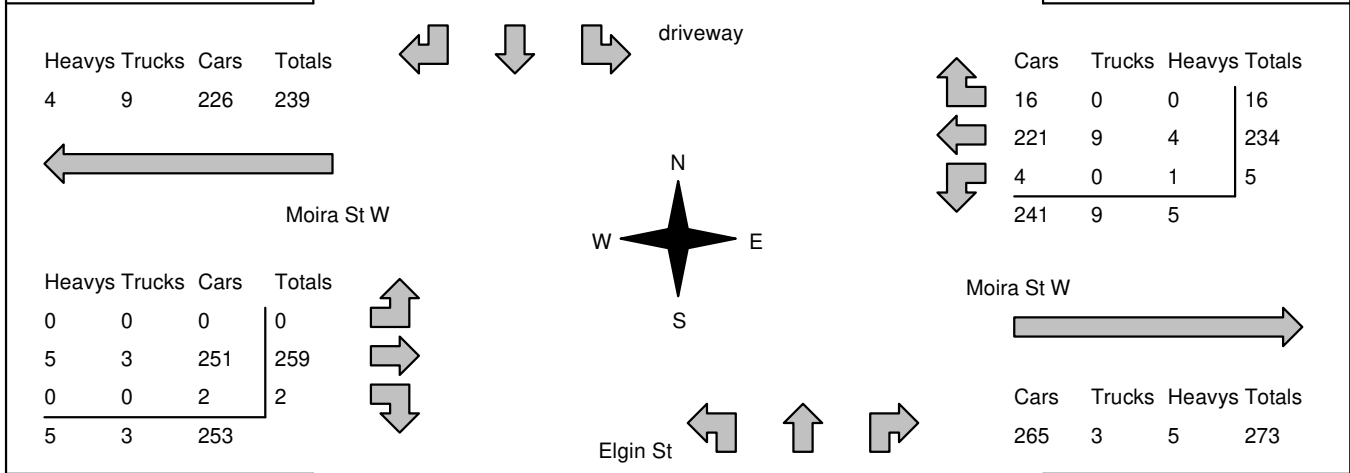

Peds Cross: ☒ West Peds: 1 West Entering: 261 West Leg Total: 500	<table style="border-collapse: collapse;"> <tr><td>Cars</td><td>6</td></tr> <tr><td>Trucks</td><td>0</td></tr> <tr><td>Heavys</td><td>1</td></tr> <tr style="border-top: 1px solid black;"><td>Totals</td><td>7</td></tr> </table>	Cars	6	Trucks	0	Heavys	1	Totals	7	↓	<table style="border-collapse: collapse;"> <tr><td>Cars</td><td>2</td><td>0</td><td>7</td><td>9</td></tr> <tr><td>Trucks</td><td>0</td><td>0</td><td>0</td><td>0</td></tr> <tr><td>Heavys</td><td>0</td><td>0</td><td>0</td><td>0</td></tr> <tr style="border-top: 1px solid black;"><td>Totals</td><td>2</td><td>0</td><td>7</td><td></td></tr> </table>	Cars	2	0	7	9	Trucks	0	0	0	0	Heavys	0	0	0	0	Totals	2	0	7		Peds Cross: ☒ South Peds: 1 South Entering: 9 South Leg Total: 16
Cars	6																															
Trucks	0																															
Heavys	1																															
Totals	7																															
Cars	2	0	7	9																												
Trucks	0	0	0	0																												
Heavys	0	0	0	0																												
Totals	2	0	7																													

Comments

Accu-Traffic Inc.

Afternoon Peak Diagram	Specified Period From: 16:00:00 To: 19:00:00	One Hour Peak From: 16:00:00 To: 17:00:00
-------------------------------	---	--

Municipality: Belleville Site #: 2104900004 Intersection: Moira St W & Elgin St TFR File #: 1 Count date: 22-Jun-21	Weather conditions: Person counted: Person prepared: Person checked:
--	---

** Non-Signalized Intersection **	Major Road: Moira St W runs W/E
--	--

North Leg Total: 59 North Entering: 25 North Peds: 1 Peds Cross: \boxtimes	<table style="border-collapse: collapse;"> <tr><td>Heavys</td><td>0</td><td>0</td><td>0</td><td>0</td></tr> <tr><td>Trucks</td><td>0</td><td>0</td><td>0</td><td>0</td></tr> <tr><td>Cars</td><td>9</td><td>0</td><td>16</td><td>25</td></tr> <tr><td>Totals</td><td>9</td><td>0</td><td>16</td><td></td></tr> </table>	Heavys	0	0	0	0	Trucks	0	0	0	0	Cars	9	0	16	25	Totals	9	0	16		↑	<table style="border-collapse: collapse;"> <tr><td>Heavys</td><td>0</td></tr> <tr><td>Trucks</td><td>0</td></tr> <tr><td>Cars</td><td>34</td></tr> <tr><td>Totals</td><td>34</td></tr> </table>	Heavys	0	Trucks	0	Cars	34	Totals	34	East Leg Total: 753 East Entering: 380 East Peds: 7 Peds Cross: \boxtimes
Heavys	0	0	0	0																												
Trucks	0	0	0	0																												
Cars	9	0	16	25																												
Totals	9	0	16																													
Heavys	0																															
Trucks	0																															
Cars	34																															
Totals	34																															

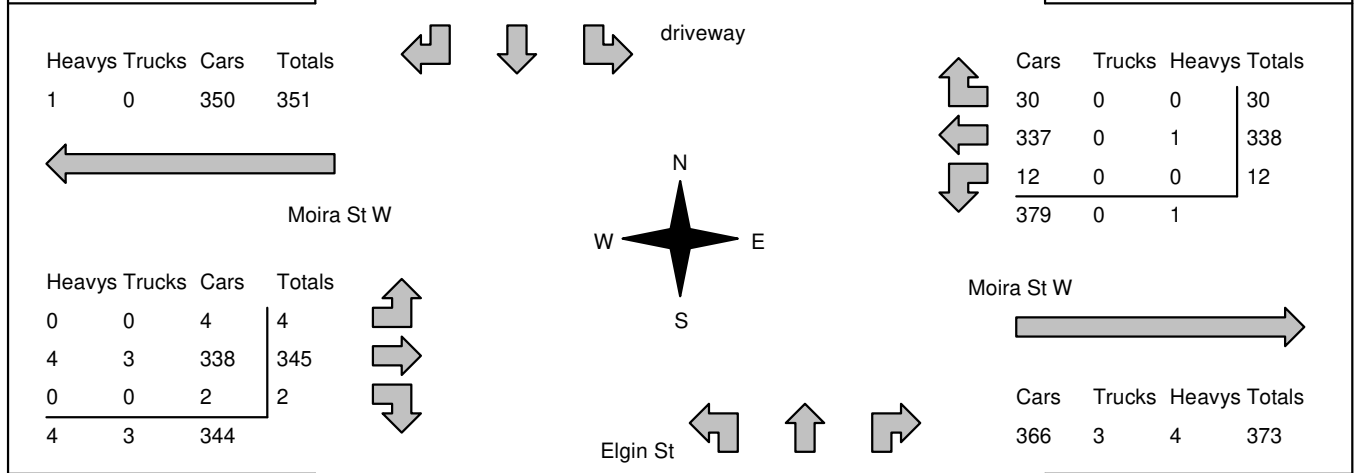

Peds Cross: \boxtimes West Peds: 3 West Entering: 351 West Leg Total: 702	<table style="border-collapse: collapse;"> <tr><td>Cars</td><td>14</td></tr> <tr><td>Trucks</td><td>0</td></tr> <tr><td>Heavys</td><td>0</td></tr> <tr><td>Totals</td><td>14</td></tr> </table>	Cars	14	Trucks	0	Heavys	0	Totals	14	<table style="border-collapse: collapse;"> <tr><td>Cars</td><td>4</td><td>0</td><td>12</td><td>16</td></tr> <tr><td>Trucks</td><td>0</td><td>0</td><td>0</td><td>0</td></tr> <tr><td>Heavys</td><td>0</td><td>0</td><td>0</td><td>0</td></tr> <tr><td>Totals</td><td>4</td><td>0</td><td>12</td><td></td></tr> </table>	Cars	4	0	12	16	Trucks	0	0	0	0	Heavys	0	0	0	0	Totals	4	0	12		Peds Cross: \boxtimes South Peds: 1 South Entering: 16 South Leg Total: 30
Cars	14																														
Trucks	0																														
Heavys	0																														
Totals	14																														
Cars	4	0	12	16																											
Trucks	0	0	0	0																											
Heavys	0	0	0	0																											
Totals	4	0	12																												

Comments

Accu-Traffic Inc.

Morning Peak Diagram	Specified Period From: 7:00:00 To: 10:00:00	One Hour Peak From: 7:45:00 To: 8:45:00
-----------------------------	--	--

Municipality: Belleville Site #: 1906400001 Intersection: Sidney St & Bridge St W TFR File #: 1 Count date: 1-May-19	Weather conditions: Person counted: Person prepared: Person checked:
---	---

** Signalized Intersection **	Major Road: Sidney St runs N/S
--------------------------------------	---------------------------------------

North Leg Total: 836 North Entering: 326 North Peds: 4 Peds Cross: \bowtie	<table style="border-collapse: collapse;"> <tr><td>Heavys</td><td>5</td><td>12</td><td>2</td><td>19</td></tr> <tr><td>Trucks</td><td>0</td><td>4</td><td>0</td><td>4</td></tr> <tr><td>Cars</td><td>53</td><td>161</td><td>89</td><td>303</td></tr> <tr><td>Totals</td><td>58</td><td>177</td><td>91</td><td></td></tr> </table>	Heavys	5	12	2	19	Trucks	0	4	0	4	Cars	53	161	89	303	Totals	58	177	91			<table style="border-collapse: collapse;"> <tr><td>Heavys</td><td>15</td></tr> <tr><td>Trucks</td><td>4</td></tr> <tr><td>Cars</td><td>491</td></tr> <tr><td>Totals</td><td>510</td></tr> </table>	Heavys	15	Trucks	4	Cars	491	Totals	510	East Leg Total: 713 East Entering: 302 East Peds: 10 Peds Cross: \bowtie
Heavys	5	12	2	19																												
Trucks	0	4	0	4																												
Cars	53	161	89	303																												
Totals	58	177	91																													
Heavys	15																															
Trucks	4																															
Cars	491																															
Totals	510																															

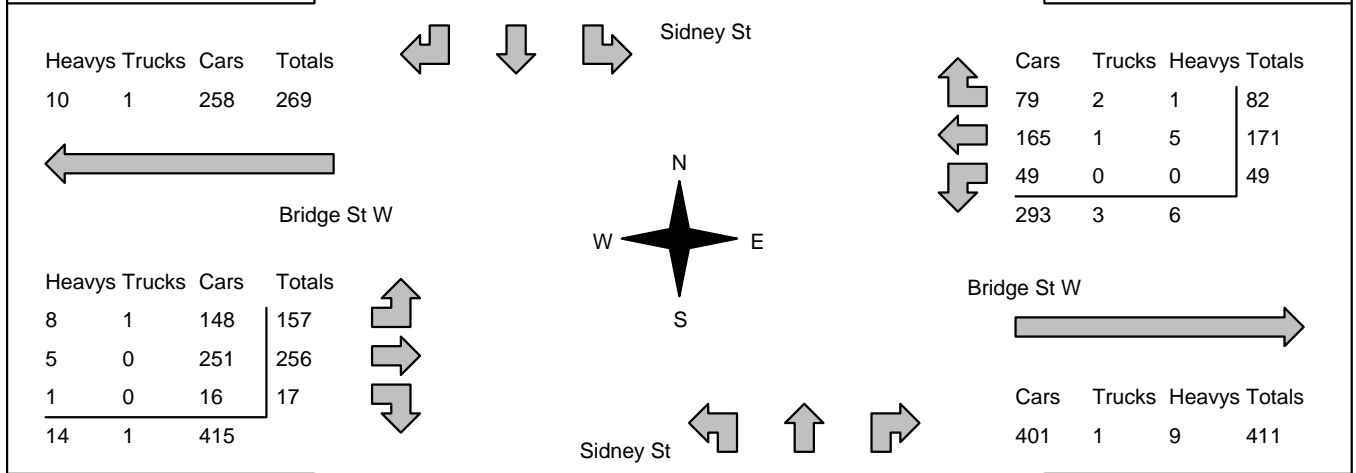

Peds Cross: \bowtie West Peds: 4 West Entering: 430 West Leg Total: 699	<table style="border-collapse: collapse;"> <tr><td>Cars</td><td>226</td></tr> <tr><td>Trucks</td><td>4</td></tr> <tr><td>Heavys</td><td>13</td></tr> <tr><td>Totals</td><td>243</td></tr> </table>	Cars	226	Trucks	4	Heavys	13	Totals	243		<table style="border-collapse: collapse;"> <tr><td>Cars</td><td>40</td><td>264</td><td>61</td><td>365</td></tr> <tr><td>Trucks</td><td>0</td><td>1</td><td>1</td><td>2</td></tr> <tr><td>Heavys</td><td>0</td><td>6</td><td>2</td><td>8</td></tr> <tr><td>Totals</td><td>40</td><td>271</td><td>64</td><td></td></tr> </table>	Cars	40	264	61	365	Trucks	0	1	1	2	Heavys	0	6	2	8	Totals	40	271	64		Peds Cross: \bowtie South Peds: 18 South Entering: 375 South Leg Total: 618
Cars	226																															
Trucks	4																															
Heavys	13																															
Totals	243																															
Cars	40	264	61	365																												
Trucks	0	1	1	2																												
Heavys	0	6	2	8																												
Totals	40	271	64																													

Comments

Accu-Traffic Inc.

Afternoon Peak Diagram	Specified Period From: 15:00:00 To: 18:00:00	One Hour Peak From: 16:15:00 To: 17:15:00
-------------------------------	---	--

Municipality: Belleville Site #: 1906400001 Intersection: Sidney St & Bridge St W TFR File #: 1 Count date: 1-May-19	Weather conditions: Person counted: Person prepared: Person checked:
---	---

** Signalized Intersection **	Major Road: Sidney St runs N/S
--------------------------------------	---------------------------------------

North Leg Total: 1172 North Entering: 510 North Peds: 6 Peds Cross: \boxtimes	<table style="width: 100%; border-collapse: collapse;"> <tr><td>Heavys</td><td>1</td><td>7</td><td>0</td><td>8</td></tr> <tr><td>Trucks</td><td>0</td><td>1</td><td>1</td><td>2</td></tr> <tr><td>Cars</td><td>123</td><td>310</td><td>67</td><td>500</td></tr> <tr><td>Totals</td><td>124</td><td>318</td><td>68</td><td></td></tr> </table>	Heavys	1	7	0	8	Trucks	0	1	1	2	Cars	123	310	67	500	Totals	124	318	68			<table style="width: 100%; border-collapse: collapse;"> <tr><td>Heavys</td><td>14</td></tr> <tr><td>Trucks</td><td>4</td></tr> <tr><td>Cars</td><td>644</td></tr> <tr><td>Totals</td><td>662</td></tr> </table>	Heavys	14	Trucks	4	Cars	644	Totals	662	East Leg Total: 659 East Entering: 365 East Peds: 14 Peds Cross: \boxtimes
Heavys	1	7	0	8																												
Trucks	0	1	1	2																												
Cars	123	310	67	500																												
Totals	124	318	68																													
Heavys	14																															
Trucks	4																															
Cars	644																															
Totals	662																															

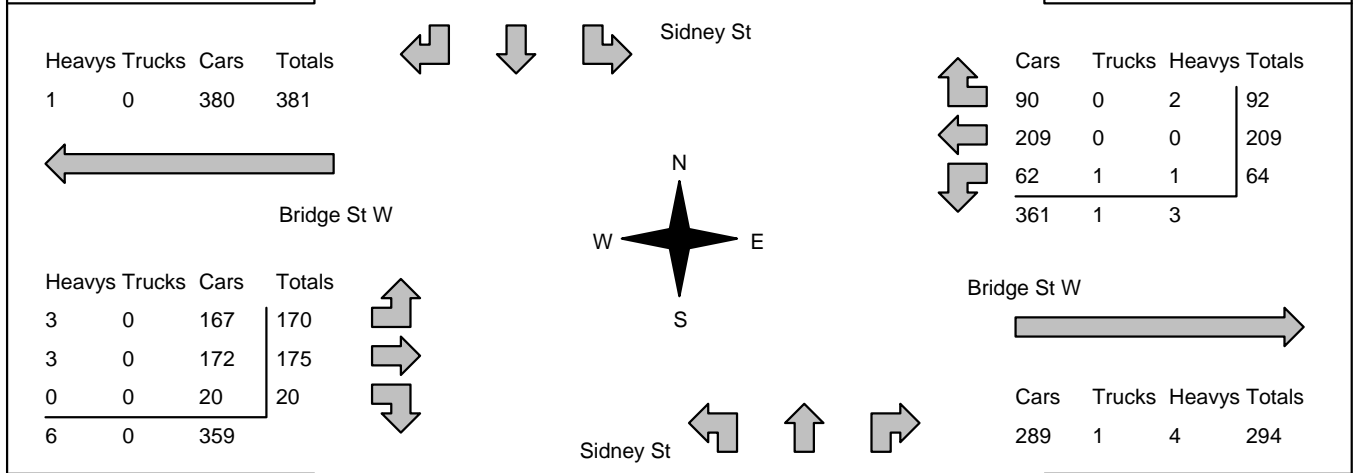

Peds Cross: \boxtimes West Peds: 3 West Entering: 365 West Leg Total: 746	<table style="width: 100%; border-collapse: collapse;"> <tr><td>Cars</td><td>392</td></tr> <tr><td>Trucks</td><td>2</td></tr> <tr><td>Heavys</td><td>8</td></tr> <tr><td>Totals</td><td>402</td></tr> </table>	Cars	392	Trucks	2	Heavys	8	Totals	402		<table style="width: 100%; border-collapse: collapse;"> <tr><td>Cars</td><td>48</td><td>387</td><td>50</td><td>485</td></tr> <tr><td>Trucks</td><td>0</td><td>4</td><td>0</td><td>4</td></tr> <tr><td>Heavys</td><td>0</td><td>9</td><td>1</td><td>10</td></tr> <tr><td>Totals</td><td>48</td><td>400</td><td>51</td><td></td></tr> </table>	Cars	48	387	50	485	Trucks	0	4	0	4	Heavys	0	9	1	10	Totals	48	400	51		Peds Cross: \boxtimes South Peds: 25 South Entering: 499 South Leg Total: 901
Cars	392																															
Trucks	2																															
Heavys	8																															
Totals	402																															
Cars	48	387	50	485																												
Trucks	0	4	0	4																												
Heavys	0	9	1	10																												
Totals	48	400	51																													

Comments

Appendix D – Synchro Analysis Output – Existing Traffic Volumes

HCM Unsignalized Intersection Capacity Analysis
 1: Palmer Rd & Bogart Cres (N)

Wilson Avenue
 Existing (2022) - AM



Movement	EBL	EBR	NBL	NBT	SBT	SBR
Lane Configurations						
Traffic Volume (veh/h)	11	8	0	93	89	4
Future Volume (Veh/h)	11	8	0	93	89	4
Sign Control	Stop			Free	Free	
Grade	0%			0%	0%	
Peak Hour Factor	0.92	0.92	0.92	0.92	0.92	0.92
Hourly flow rate (vph)	12	9	0	101	97	4
Pedestrians						
Lane Width (m)						
Walking Speed (m/s)						
Percent Blockage						
Right turn flare (veh)						
Median type				None	None	
Median storage veh						
Upstream signal (m)						
pX, platoon unblocked						
vC, conflicting volume	200	99	101			
vC1, stage 1 conf vol						
vC2, stage 2 conf vol						
vCu, unblocked vol	200	99	101			
tC, single (s)	6.4	6.2	4.1			
tC, 2 stage (s)						
tF (s)	3.5	3.3	2.2			
p0 queue free %	98	99	100			
cM capacity (veh/h)	789	957	1491			
Direction, Lane #	EB 1	NB 1	SB 1			
Volume Total	21	101	101			
Volume Left	12	0	0			
Volume Right	9	0	4			
cSH	853	1491	1700			
Volume to Capacity	0.02	0.00	0.06			
Queue Length 95th (m)	0.6	0.0	0.0			
Control Delay (s)	9.3	0.0	0.0			
Lane LOS	A					
Approach Delay (s)	9.3	0.0	0.0			
Approach LOS	A					
Intersection Summary						
Average Delay			0.9			
Intersection Capacity Utilization			14.9%	ICU Level of Service	A	
Analysis Period (min)			15			

HCM Unsignalized Intersection Capacity Analysis
 2: Sidney St & Wilson Ave

Wilson Avenue
 Existing (2022) - AM



Movement	EBL	EBR	NBL	NBT	SBT	SBR
Lane Configurations						
Traffic Volume (veh/h)	5	12	7	430	441	21
Future Volume (Veh/h)	5	12	7	430	441	21
Sign Control	Stop			Free	Free	
Grade	0%			0%	0%	
Peak Hour Factor	0.92	0.92	0.92	0.92	0.92	0.92
Hourly flow rate (vph)	5	13	8	467	479	23
Pedestrians						
Lane Width (m)						
Walking Speed (m/s)						
Percent Blockage						
Right turn flare (veh)						
Median type				None	None	
Median storage veh						
Upstream signal (m)						
pX, platoon unblocked						
vC, conflicting volume	740	251	502			
vC1, stage 1 conf vol						
vC2, stage 2 conf vol						
vCu, unblocked vol	740	251	502			
tC, single (s)	6.8	6.9	4.1			
tC, 2 stage (s)						
tF (s)	3.5	3.3	2.2			
p0 queue free %	99	98	99			
cM capacity (veh/h)	350	749	1059			
Direction, Lane #	EB 1	NB 1	NB 2	SB 1	SB 2	
Volume Total	18	164	311	319	183	
Volume Left	5	8	0	0	0	
Volume Right	13	0	0	0	23	
cSH	568	1059	1700	1700	1700	
Volume to Capacity	0.03	0.01	0.18	0.19	0.11	
Queue Length 95th (m)	0.7	0.2	0.0	0.0	0.0	
Control Delay (s)	11.5	0.5	0.0	0.0	0.0	
Lane LOS	B	A				
Approach Delay (s)	11.5	0.2		0.0		
Approach LOS	B					
Intersection Summary						
Average Delay	0.3					
Intersection Capacity Utilization	26.8%			ICU Level of Service	A	
Analysis Period (min)	15					

HCM Unsignalized Intersection Capacity Analysis
3: Tripp Ave & Moira St W

















Wilson Avenue
Existing (2022) - AM



Movement	EBT	EBR	WBL	WBT	NBL	NBR
Lane Configurations	→			←	←	↗
Traffic Volume (veh/h)	332	7	18	323	1	30
Future Volume (Veh/h)	332	7	18	323	1	30
Sign Control	Free			Free	Stop	
Grade	0%			0%	0%	
Peak Hour Factor	0.92	0.92	0.92	0.92	0.92	0.92
Hourly flow rate (vph)	361	8	20	351	1	33
Pedestrians						
Lane Width (m)						
Walking Speed (m/s)						
Percent Blockage						
Right turn flare (veh)						
Median type	None		None			
Median storage (veh)						
Upstream signal (m)						
pX, platoon unblocked						
vC, conflicting volume			369		756	365
vC1, stage 1 conf vol						
vC2, stage 2 conf vol						
vCu, unblocked vol			369		756	365
tC, single (s)			4.1		6.4	6.2
tC, 2 stage (s)						
tF (s)			2.2		3.5	3.3
p0 queue free %			98		100	95
cM capacity (veh/h)			1190		370	680
Direction, Lane #	EB 1	WB 1	NB 1			
Volume Total	369	371	34			
Volume Left	0	20	1			
Volume Right	8	0	33			
cSH	1700	1190	664			
Volume to Capacity	0.22	0.02	0.05			
Queue Length 95th (m)	0.0	0.4	1.2			
Control Delay (s)	0.0	0.6	10.7			
Lane LOS		A	B			
Approach Delay (s)	0.0	0.6	10.7			
Approach LOS			B			
Intersection Summary						
Average Delay			0.8			
Intersection Capacity Utilization			41.7%	ICU Level of Service	A	
Analysis Period (min)			15			

HCM Unsignalized Intersection Capacity Analysis
4: Elgin St/Driveway & Moira St W

Wilson Avenue
Existing (2022) - AM

												
Movement	EBL	EBT	EBR	WBL	WBT	WBR	NBL	NBT	NBR	SBL	SBT	SBR
Lane Configurations												
Traffic Volume (veh/h)	0	360	3	7	325	22	3	0	10	10	0	4
Future Volume (Veh/h)	0	360	3	7	325	22	3	0	10	10	0	4
Sign Control		Free			Free			Stop			Stop	
Grade		0%			0%			0%			0%	
Peak Hour Factor	0.92	0.92	0.92	0.92	0.92	0.92	0.92	0.92	0.92	0.92	0.92	0.92
Hourly flow rate (vph)	0	391	3	8	353	24	3	0	11	11	0	4
Pedestrians												
Lane Width (m)												
Walking Speed (m/s)												
Percent Blockage												
Right turn flare (veh)												
Median type		None			None							
Median storage (veh)												
Upstream signal (m)												
pX, platoon unblocked												
vC, conflicting volume	377			394			778	786	392	784	775	365
vC1, stage 1 conf vol												
vC2, stage 2 conf vol												
vCu, unblocked vol	377			394			778	786	392	784	775	365
tC, single (s)	4.1			4.1			7.1	6.5	6.2	7.1	6.5	6.2
tC, 2 stage (s)												
tF (s)	2.2			2.2			3.5	4.0	3.3	3.5	4.0	3.3
p0 queue free %	100			99			99	100	98	96	100	99
cM capacity (veh/h)	1181			1165			310	322	656	304	327	680
Direction, Lane #	EB 1	WB 1	NB 1	SB 1								
Volume Total	394	385	14	15								
Volume Left	0	8	3	11								
Volume Right	3	24	11	4								
cSH	1181	1165	530	356								
Volume to Capacity	0.00	0.01	0.03	0.04								
Queue Length 95th (m)	0.0	0.2	0.6	1.0								
Control Delay (s)	0.0	0.2	12.0	15.5								
Lane LOS		A	B	C								
Approach Delay (s)	0.0	0.2	12.0	15.5								
Approach LOS			B	C								
Intersection Summary												
Average Delay			0.6									
Intersection Capacity Utilization			34.1%		ICU Level of Service				A			
Analysis Period (min)			15									

HCM Unsignalized Intersection Capacity Analysis
 1: Palmer Rd & Bogart Cres (N)

Wilson Avenue
 Existing (2022) - PM



Movement	EBL	EBR	NBL	NBT	SBT	SBR
Lane Configurations						
Traffic Volume (veh/h)	5	5	7	132	204	10
Future Volume (Veh/h)	5	5	7	132	204	10
Sign Control	Stop			Free	Free	
Grade	0%			0%	0%	
Peak Hour Factor	0.92	0.92	0.92	0.92	0.92	0.92
Hourly flow rate (vph)	5	5	8	143	222	11
Pedestrians						
Lane Width (m)						
Walking Speed (m/s)						
Percent Blockage						
Right turn flare (veh)						
Median type				None	None	
Median storage veh						
Upstream signal (m)						
pX, platoon unblocked						
vC, conflicting volume	386	228	233			
vC1, stage 1 conf vol						
vC2, stage 2 conf vol						
vCu, unblocked vol	386	228	233			
tC, single (s)	6.4	6.2	4.1			
tC, 2 stage (s)						
tF (s)	3.5	3.3	2.2			
p0 queue free %	99	99	99			
cM capacity (veh/h)	613	812	1335			
Direction, Lane #	EB 1	NB 1	SB 1			
Volume Total	10	151	233			
Volume Left	5	8	0			
Volume Right	5	0	11			
cSH	699	1335	1700			
Volume to Capacity	0.01	0.01	0.14			
Queue Length 95th (m)	0.3	0.1	0.0			
Control Delay (s)	10.2	0.5	0.0			
Lane LOS	B	A				
Approach Delay (s)	10.2	0.5	0.0			
Approach LOS	B					
Intersection Summary						
Average Delay			0.4			
Intersection Capacity Utilization			22.7%	ICU Level of Service	A	
Analysis Period (min)			15			

HCM Unsignalized Intersection Capacity Analysis
 2: Sidney St & Wilson Ave

Wilson Avenue
 Existing (2022) - PM



Movement	EBL	EBR	NBL	NBT	SBT	SBR
Lane Configurations						
Traffic Volume (veh/h)	12	4	4	795	521	10
Future Volume (Veh/h)	12	4	4	795	521	10
Sign Control	Stop			Free	Free	
Grade	0%			0%	0%	
Peak Hour Factor	0.92	0.92	0.92	0.92	0.92	0.92
Hourly flow rate (vph)	13	4	4	864	566	11
Pedestrians						
Lane Width (m)						
Walking Speed (m/s)						
Percent Blockage						
Right turn flare (veh)						
Median type				None	None	
Median storage veh						
Upstream signal (m)						
pX, platoon unblocked						
vC, conflicting volume	1012	288	577			
vC1, stage 1 conf vol						
vC2, stage 2 conf vol						
vCu, unblocked vol	1012	288	577			
tC, single (s)	6.8	6.9	4.1			
tC, 2 stage (s)						
tF (s)	3.5	3.3	2.2			
p0 queue free %	94	99	100			
cM capacity (veh/h)	235	708	993			
Direction, Lane #	EB 1	NB 1	NB 2	SB 1	SB 2	
Volume Total	17	292	576	377	200	
Volume Left	13	4	0	0	0	
Volume Right	4	0	0	0	11	
cSH	279	993	1700	1700	1700	
Volume to Capacity	0.06	0.00	0.34	0.22	0.12	
Queue Length 95th (m)	1.5	0.1	0.0	0.0	0.0	
Control Delay (s)	18.8	0.2	0.0	0.0	0.0	
Lane LOS	C	A				
Approach Delay (s)	18.8	0.1		0.0		
Approach LOS	C					
Intersection Summary						
Average Delay	0.3					
Intersection Capacity Utilization	34.8%			ICU Level of Service	A	
Analysis Period (min)	15					

HCM Unsignalized Intersection Capacity Analysis
3: Tripp Ave & Moira St W



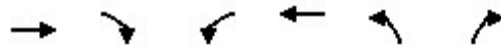













Wilson Avenue
Existing (2022) - PM



Movement	EBT	EBR	WBL	WBT	NBL	NBR
Lane Configurations	↩			↩	↩	
Traffic Volume (veh/h)	396	7	55	477	3	49
Future Volume (Veh/h)	396	7	55	477	3	49
Sign Control	Free			Free	Stop	
Grade	0%			0%	0%	
Peak Hour Factor	0.92	0.92	0.92	0.92	0.92	0.92
Hourly flow rate (vph)	430	8	60	518	3	53
Pedestrians						
Lane Width (m)						
Walking Speed (m/s)						
Percent Blockage						
Right turn flare (veh)						
Median type	None		None			
Median storage veh						
Upstream signal (m)						
pX, platoon unblocked						
vC, conflicting volume			438		1072	434
vC1, stage 1 conf vol						
vC2, stage 2 conf vol						
vCu, unblocked vol			438		1072	434
tC, single (s)			4.1		6.4	6.2
tC, 2 stage (s)						
tF (s)			2.2		3.5	3.3
p0 queue free %			95		99	91
cM capacity (veh/h)			1122		231	622
Direction, Lane #	EB 1	WB 1	NB 1			
Volume Total	438	578	56			
Volume Left	0	60	3			
Volume Right	8	0	53			
cSH	1700	1122	570			
Volume to Capacity	0.26	0.05	0.10			
Queue Length 95th (m)	0.0	1.3	2.5			
Control Delay (s)	0.0	1.4	12.0			
Lane LOS			A	B		
Approach Delay (s)	0.0	1.4	12.0			
Approach LOS			B			
Intersection Summary						
Average Delay			1.4			
Intersection Capacity Utilization			62.7%	ICU Level of Service		B
Analysis Period (min)			15			

HCM Unsignalized Intersection Capacity Analysis
4: Elgin St/Driveway & Moira St W

Wilson Avenue
Existing (2022) - PM

												
Movement	EBL	EBT	EBR	WBL	WBT	WBR	NBL	NBT	NBR	SBL	SBT	SBR
Lane Configurations												
Traffic Volume (veh/h)	5	480	3	16	470	41	5	0	16	22	0	12
Future Volume (Veh/h)	5	480	3	16	470	41	5	0	16	22	0	12
Sign Control		Free			Free			Stop			Stop	
Grade		0%			0%			0%			0%	
Peak Hour Factor	0.92	0.92	0.92	0.92	0.92	0.92	0.92	0.92	0.92	0.92	0.92	0.92
Hourly flow rate (vph)	5	522	3	17	511	45	5	0	17	24	0	13
Pedestrians												
Lane Width (m)												
Walking Speed (m/s)												
Percent Blockage												
Right turn flare (veh)												
Median type	None					None						
Median storage (veh)												
Upstream signal (m)												
pX, platoon unblocked												
vC, conflicting volume	556			525			1114	1124	524	1118	1102	534
vC1, stage 1 conf vol												
vC2, stage 2 conf vol												
vCu, unblocked vol	556			525			1114	1124	524	1118	1102	534
tC, single (s)	4.1			4.1			7.1	6.5	6.2	7.1	6.5	6.2
tC, 2 stage (s)												
tF (s)	2.2			2.2			3.5	4.0	3.3	3.5	4.0	3.3
p0 queue free %	100			98			97	100	97	86	100	98
cM capacity (veh/h)	1015			1042			178	201	554	176	207	546
Direction, Lane #	EB 1	WB 1	NB 1	SB 1								
Volume Total	530	573	22	37								
Volume Left	5	17	5	24								
Volume Right	3	45	17	13								
cSH	1015	1042	374	231								
Volume to Capacity	0.00	0.02	0.06	0.16								
Queue Length 95th (m)	0.1	0.4	1.4	4.3								
Control Delay (s)	0.1	0.5	15.2	23.6								
Lane LOS	A	A	C	C								
Approach Delay (s)	0.1	0.5	15.2	23.6								
Approach LOS			C	C								
Intersection Summary												
Average Delay			1.3									
Intersection Capacity Utilization			48.5%	ICU Level of Service	A							
Analysis Period (min)			15									

Appendix E – Synchro Analysis Output – Background Traffic Volumes

HCM Unsignalized Intersection Capacity Analysis
 1: Palmer Rd & Bogart Cres (N)

Wilson Avenue
 BG (2029) - AM



Movement	EBL	EBR	NBL	NBT	SBT	SBR
Lane Configurations						
Traffic Volume (veh/h)	11	8	0	105	106	4
Future Volume (Veh/h)	11	8	0	105	106	4
Sign Control	Stop			Free	Free	
Grade	0%			0%	0%	
Peak Hour Factor	0.92	0.92	0.92	0.92	0.92	0.92
Hourly flow rate (vph)	12	9	0	114	115	4
Pedestrians						
Lane Width (m)						
Walking Speed (m/s)						
Percent Blockage						
Right turn flare (veh)						
Median type				None	None	
Median storage (veh)						
Upstream signal (m)						
pX, platoon unblocked						
vC, conflicting volume	231	117	119			
vC1, stage 1 conf vol						
vC2, stage 2 conf vol						
vCu, unblocked vol	231	117	119			
tC, single (s)	6.4	6.2	4.1			
tC, 2 stage (s)						
tF (s)	3.5	3.3	2.2			
p0 queue free %	98	99	100			
cM capacity (veh/h)	757	935	1469			
Direction, Lane #	EB 1	NB 1	SB 1			
Volume Total	21	114	119			
Volume Left	12	0	0			
Volume Right	9	0	4			
cSH	824	1469	1700			
Volume to Capacity	0.03	0.00	0.07			
Queue Length 95th (m)	0.6	0.0	0.0			
Control Delay (s)	9.5	0.0	0.0			
Lane LOS	A					
Approach Delay (s)	9.5	0.0	0.0			
Approach LOS	A					
Intersection Summary						
Average Delay			0.8			
Intersection Capacity Utilization			15.8%	ICU Level of Service	A	
Analysis Period (min)			15			

HCM Unsignalized Intersection Capacity Analysis
2: Sidney St & Wilson Ave

Wilson Avenue
BG (2029) - AM



Movement	EBL	EBR	NBL	NBT	SBT	SBR
Lane Configurations						
Traffic Volume (veh/h)	5	12	7	543	558	21
Future Volume (Veh/h)	5	12	7	543	558	21
Sign Control	Stop			Free	Free	
Grade	0%			0%	0%	
Peak Hour Factor	0.92	0.92	0.92	0.92	0.92	0.92
Hourly flow rate (vph)	5	13	8	590	607	23
Pedestrians						
Lane Width (m)						
Walking Speed (m/s)						
Percent Blockage						
Right turn flare (veh)						
Median type				None	None	
Median storage veh						
Upstream signal (m)						
pX, platoon unblocked						
vC, conflicting volume	930	315	630			
vC1, stage 1 conf vol						
vC2, stage 2 conf vol						
vCu, unblocked vol	930	315	630			
tC, single (s)	6.8	6.9	4.1			
tC, 2 stage (s)						
tF (s)	3.5	3.3	2.2			
p0 queue free %	98	98	99			
cM capacity (veh/h)	264	681	948			
Direction, Lane #	EB 1	NB 1	NB 2	SB 1	SB 2	
Volume Total	18	205	393	405	225	
Volume Left	5	8	0	0	0	
Volume Right	13	0	0	0	23	
cSH	473	948	1700	1700	1700	
Volume to Capacity	0.04	0.01	0.23	0.24	0.13	
Queue Length 95th (m)	0.9	0.2	0.0	0.0	0.0	
Control Delay (s)	12.9	0.4	0.0	0.0	0.0	
Lane LOS	B	A				
Approach Delay (s)	12.9	0.1		0.0		
Approach LOS	B					
Intersection Summary						
Average Delay	0.3					
Intersection Capacity Utilization	29.9%			ICU Level of Service	A	
Analysis Period (min)	15					

HCM Unsignalized Intersection Capacity Analysis
3: Tripp Ave & Moira St W



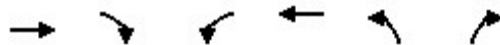













Wilson Avenue
BG (2029) - AM



Movement	EBT	EBR	WBL	WBT	NBL	NBR
Lane Configurations	→			←	↔	
Traffic Volume (veh/h)	388	7	18	370	1	30
Future Volume (Veh/h)	388	7	18	370	1	30
Sign Control	Free			Free	Stop	
Grade	0%			0%	0%	
Peak Hour Factor	0.92	0.92	0.92	0.92	0.92	0.92
Hourly flow rate (vph)	422	8	20	402	1	33
Pedestrians						
Lane Width (m)						
Walking Speed (m/s)						
Percent Blockage						
Right turn flare (veh)						
Median type	None		None			
Median storage (veh)						
Upstream signal (m)						
pX, platoon unblocked						
vC, conflicting volume			430		868	426
vC1, stage 1 conf vol						
vC2, stage 2 conf vol						
vCu, unblocked vol			430		868	426
tC, single (s)			4.1		6.4	6.2
tC, 2 stage (s)						
tF (s)			2.2		3.5	3.3
p0 queue free %			98		100	95
cM capacity (veh/h)			1129		317	628
Direction, Lane #	EB 1	WB 1	NB 1			
Volume Total	430	422	34			
Volume Left	0	20	1			
Volume Right	8	0	33			
cSH	1700	1129	611			
Volume to Capacity	0.25	0.02	0.06			
Queue Length 95th (m)	0.0	0.4	1.3			
Control Delay (s)	0.0	0.6	11.2			
Lane LOS	A		B			
Approach Delay (s)	0.0	0.6	11.2			
Approach LOS			B			
Intersection Summary						
Average Delay			0.7			
Intersection Capacity Utilization			44.1%	ICU Level of Service	A	
Analysis Period (min)			15			

HCM Unsignalized Intersection Capacity Analysis
4: Elgin St/Driveway & Moira St W

Wilson Avenue
BG (2029) - AM

												
Movement	EBL	EBT	EBR	WBL	WBT	WBR	NBL	NBT	NBR	SBL	SBT	SBR
Lane Configurations												
Traffic Volume (veh/h)	0	419	3	7	373	22	3	0	10	10	0	4
Future Volume (Veh/h)	0	419	3	7	373	22	3	0	10	10	0	4
Sign Control		Free			Free			Stop			Stop	
Grade		0%			0%			0%			0%	
Peak Hour Factor	0.92	0.92	0.92	0.92	0.92	0.92	0.92	0.92	0.92	0.92	0.92	0.92
Hourly flow rate (vph)	0	455	3	8	405	24	3	0	11	11	0	4
Pedestrians												
Lane Width (m)												
Walking Speed (m/s)												
Percent Blockage												
Right turn flare (veh)												
Median type		None			None							
Median storage (veh)												
Upstream signal (m)												
pX, platoon unblocked												
vC, conflicting volume	429			458			894	902	456	900	891	417
vC1, stage 1 conf vol												
vC2, stage 2 conf vol												
vCu, unblocked vol	429			458			894	902	456	900	891	417
tC, single (s)	4.1			4.1			7.1	6.5	6.2	7.1	6.5	6.2
tC, 2 stage (s)												
tF (s)	2.2			2.2			3.5	4.0	3.3	3.5	4.0	3.3
p0 queue free %	100			99			99	100	98	96	100	99
cM capacity (veh/h)	1130			1103			259	276	604	253	280	636
Direction, Lane #	EB 1	WB 1	NB 1	SB 1								
Volume Total	458	437	14	15								
Volume Left	0	8	3	11								
Volume Right	3	24	11	4								
cSH	1130	1103	470	302								
Volume to Capacity	0.00	0.01	0.03	0.05								
Queue Length 95th (m)	0.0	0.2	0.7	1.2								
Control Delay (s)	0.0	0.2	12.9	17.6								
Lane LOS		A	B	C								
Approach Delay (s)	0.0	0.2	12.9	17.6								
Approach LOS			B	C								
Intersection Summary												
Average Delay			0.6									
Intersection Capacity Utilization			36.6%		ICU Level of Service				A			
Analysis Period (min)			15									

HCM Unsignalized Intersection Capacity Analysis
 1: Palmer Rd & Bogart Cres (N)

Wilson Avenue
 Background (2029) - PM



Movement	EBL	EBR	NBL	NBT	SBT	SBR
Lane Configurations						
Traffic Volume (veh/h)	5	5	7	155	232	10
Future Volume (Veh/h)	5	5	7	155	232	10
Sign Control	Stop			Free	Free	
Grade	0%			0%	0%	
Peak Hour Factor	0.92	0.92	0.92	0.92	0.92	0.92
Hourly flow rate (vph)	5	5	8	168	252	11
Pedestrians						
Lane Width (m)						
Walking Speed (m/s)						
Percent Blockage						
Right turn flare (veh)						
Median type				None	None	
Median storage veh						
Upstream signal (m)						
pX, platoon unblocked						
vC, conflicting volume	442	258	263			
vC1, stage 1 conf vol						
vC2, stage 2 conf vol						
vCu, unblocked vol	442	258	263			
tC, single (s)	6.4	6.2	4.1			
tC, 2 stage (s)						
tF (s)	3.5	3.3	2.2			
p0 queue free %	99	99	99			
cM capacity (veh/h)	570	781	1301			
Direction, Lane #	EB 1	NB 1	SB 1			
Volume Total	10	176	263			
Volume Left	5	8	0			
Volume Right	5	0	11			
cSH	659	1301	1700			
Volume to Capacity	0.02	0.01	0.15			
Queue Length 95th (m)	0.4	0.1	0.0			
Control Delay (s)	10.5	0.4	0.0			
Lane LOS	B	A				
Approach Delay (s)	10.5	0.4	0.0			
Approach LOS	B					
Intersection Summary						
Average Delay			0.4			
Intersection Capacity Utilization			23.8%	ICU Level of Service	A	
Analysis Period (min)			15			

HCM Unsignalized Intersection Capacity Analysis

2: Sidney St & Wilson Ave

Wilson Avenue
Background (2029) - PM



Movement	EBL	EBR	NBL	NBT	SBT	SBR
Lane Configurations						
Traffic Volume (veh/h)	12	4	4	1000	712	10
Future Volume (Veh/h)	12	4	4	1000	712	10
Sign Control	Stop			Free	Free	
Grade	0%			0%	0%	
Peak Hour Factor	0.92	0.92	0.92	0.92	0.92	0.92
Hourly flow rate (vph)	13	4	4	1087	774	11
Pedestrians						
Lane Width (m)						
Walking Speed (m/s)						
Percent Blockage						
Right turn flare (veh)						
Median type				None	None	
Median storage veh						
Upstream signal (m)						
pX, platoon unblocked						
vC, conflicting volume	1331	392	785			
vC1, stage 1 conf vol						
vC2, stage 2 conf vol						
vCu, unblocked vol	1331	392	785			
tC, single (s)	6.8	6.9	4.1			
tC, 2 stage (s)						
tF (s)	3.5	3.3	2.2			
p0 queue free %	91	99	100			
cM capacity (veh/h)	145	606	829			
Direction, Lane #	EB 1	NB 1	NB 2	SB 1	SB 2	
Volume Total	17	366	725	516	269	
Volume Left	13	4	0	0	0	
Volume Right	4	0	0	0	11	
cSH	177	829	1700	1700	1700	
Volume to Capacity	0.10	0.00	0.43	0.30	0.16	
Queue Length 95th (m)	2.4	0.1	0.0	0.0	0.0	
Control Delay (s)	27.5	0.2	0.0	0.0	0.0	
Lane LOS	D	A				
Approach Delay (s)	27.5	0.1		0.0		
Approach LOS	D					
Intersection Summary						
Average Delay	0.3					
Intersection Capacity Utilization	40.4%			ICU Level of Service	A	
Analysis Period (min)	15					

HCM Unsignalized Intersection Capacity Analysis
3: Tripp Ave & Moira St W

Wilson Avenue
Background (2029) - PM



Movement	EBT	EBR	WBL	WBT	NBL	NBR
Lane Configurations	→			←	←	↘
Traffic Volume (veh/h)	465	7	55	555	3	49
Future Volume (Veh/h)	465	7	55	555	3	49
Sign Control	Free			Free	Stop	
Grade	0%			0%	0%	
Peak Hour Factor	0.92	0.92	0.92	0.92	0.92	0.92
Hourly flow rate (vph)	505	8	60	603	3	53
Pedestrians						
Lane Width (m)						
Walking Speed (m/s)						
Percent Blockage						
Right turn flare (veh)						
Median type	None		None			
Median storage (veh)						
Upstream signal (m)						
pX, platoon unblocked						
vC, conflicting volume			513		1232	509
vC1, stage 1 conf vol						
vC2, stage 2 conf vol						
vCu, unblocked vol			513		1232	509
tC, single (s)			4.1		6.4	6.2
tC, 2 stage (s)						
tF (s)			2.2		3.5	3.3
p0 queue free %			94		98	91
cM capacity (veh/h)			1052		184	564
Direction, Lane #	EB 1	WB 1	NB 1			
Volume Total	513	663	56			
Volume Left	0	60	3			
Volume Right	8	0	53			
cSH	1700	1052	508			
Volume to Capacity	0.30	0.06	0.11			
Queue Length 95th (m)	0.0	1.4	2.8			
Control Delay (s)	0.0	1.5	13.0			
Lane LOS		A	B			
Approach Delay (s)	0.0	1.5	13.0			
Approach LOS			B			
Intersection Summary						
Average Delay			1.4			
Intersection Capacity Utilization			70.5%	ICU Level of Service	C	
Analysis Period (min)			15			

HCM Unsignalized Intersection Capacity Analysis
4: Elgin St/Driveway & Moira St W

Wilson Avenue
Background (2029) - PM



Movement	EBL	EBT	EBR	WBL	WBT	WBR	NBL	NBT	NBR	SBL	SBT	SBR
Lane Configurations		↕			↕			↕			↕	
Traffic Volume (veh/h)	5	557	3	16	548	41	5	0	16	22	0	12
Future Volume (Veh/h)	5	557	3	16	548	41	5	0	16	22	0	12
Sign Control		Free			Free			Stop			Stop	
Grade		0%			0%			0%			0%	
Peak Hour Factor	0.92	0.92	0.92	0.92	0.92	0.92	0.92	0.92	0.92	0.92	0.92	0.92
Hourly flow rate (vph)	5	605	3	17	596	45	5	0	17	24	0	13
Pedestrians												
Lane Width (m)												
Walking Speed (m/s)												
Percent Blockage												
Right turn flare (veh)												
Median type	None				None							
Median storage (veh)												
Upstream signal (m)												
pX, platoon unblocked												
vC, conflicting volume	641			608			1282	1292	606	1286	1270	618
vC1, stage 1 conf vol												
vC2, stage 2 conf vol												
vCu, unblocked vol	641			608			1282	1292	606	1286	1270	618
tC, single (s)	4.1			4.1			7.1	6.5	6.2	7.1	6.5	6.2
tC, 2 stage (s)												
tF (s)	2.2			2.2			3.5	4.0	3.3	3.5	4.0	3.3
p0 queue free %	99			98			96	100	97	82	100	97
cM capacity (veh/h)	943			970			136	159	497	134	164	489
Direction, Lane #												
	EB 1	WB 1	NB 1	SB 1								
Volume Total	613	658	22	37								
Volume Left	5	17	5	24								
Volume Right	3	45	17	13								
cSH	943	970	310	180								
Volume to Capacity	0.01	0.02	0.07	0.21								
Queue Length 95th (m)	0.1	0.4	1.7	5.7								
Control Delay (s)	0.1	0.5	17.5	30.1								
Lane LOS	A	A	C	D								
Approach Delay (s)	0.1	0.5	17.5	30.1								
Approach LOS			C	D								
Intersection Summary												
Average Delay			1.4									
Intersection Capacity Utilization			52.9%	ICU Level of Service	A							
Analysis Period (min)			15									

HCM Unsignalized Intersection Capacity Analysis

1: Palmer Rd & Bogart Cres (N)

Wilson Avenue
BG (2034) - AM



Movement	EBL	EBR	NBL	NBT	SBT	SBR
Lane Configurations						
Traffic Volume (veh/h)	11	8	0	113	113	4
Future Volume (Veh/h)	11	8	0	113	113	4
Sign Control	Stop			Free	Free	
Grade	0%			0%	0%	
Peak Hour Factor	0.92	0.92	0.92	0.92	0.92	0.92
Hourly flow rate (vph)	12	9	0	123	123	4
Pedestrians						
Lane Width (m)						
Walking Speed (m/s)						
Percent Blockage						
Right turn flare (veh)						
Median type				None	None	
Median storage (veh)						
Upstream signal (m)						
pX, platoon unblocked						
vC, conflicting volume	248	125	127			
vC1, stage 1 conf vol						
vC2, stage 2 conf vol						
vCu, unblocked vol	248	125	127			
tC, single (s)	6.4	6.2	4.1			
tC, 2 stage (s)						
tF (s)	3.5	3.3	2.2			
p0 queue free %	98	99	100			
cM capacity (veh/h)	740	926	1459			
Direction, Lane #	EB 1	NB 1	SB 1			
Volume Total	21	123	127			
Volume Left	12	0	0			
Volume Right	9	0	4			
cSH	810	1459	1700			
Volume to Capacity	0.03	0.00	0.07			
Queue Length 95th (m)	0.6	0.0	0.0			
Control Delay (s)	9.6	0.0	0.0			
Lane LOS	A					
Approach Delay (s)	9.6	0.0	0.0			
Approach LOS	A					
Intersection Summary						
Average Delay			0.7			
Intersection Capacity Utilization			16.2%	ICU Level of Service	A	
Analysis Period (min)			15			

HCM Unsignalized Intersection Capacity Analysis
2: Sidney St & Wilson Ave

Wilson Avenue
BG (2034) - AM



Movement	EBL	EBR	NBL	NBT	SBT	SBR
Lane Configurations						
Traffic Volume (veh/h)	5	12	7	580	596	21
Future Volume (Veh/h)	5	12	7	580	596	21
Sign Control	Stop			Free	Free	
Grade	0%			0%	0%	
Peak Hour Factor	0.92	0.92	0.92	0.92	0.92	0.92
Hourly flow rate (vph)	5	13	8	630	648	23
Pedestrians						
Lane Width (m)						
Walking Speed (m/s)						
Percent Blockage						
Right turn flare (veh)						
Median type				None	None	
Median storage (veh)						
Upstream signal (m)						
pX, platoon unblocked						
vC, conflicting volume	990	336	671			
vC1, stage 1 conf vol						
vC2, stage 2 conf vol						
vCu, unblocked vol	990	336	671			
tC, single (s)	6.8	6.9	4.1			
tC, 2 stage (s)						
tF (s)	3.5	3.3	2.2			
p0 queue free %	98	98	99			
cM capacity (veh/h)	241	660	915			
Direction, Lane #	EB 1	NB 1	NB 2	SB 1	SB 2	
Volume Total	18	218	420	432	239	
Volume Left	5	8	0	0	0	
Volume Right	13	0	0	0	23	
cSH	445	915	1700	1700	1700	
Volume to Capacity	0.04	0.01	0.25	0.25	0.14	
Queue Length 95th (m)	1.0	0.2	0.0	0.0	0.0	
Control Delay (s)	13.4	0.4	0.0	0.0	0.0	
Lane LOS	B	A				
Approach Delay (s)	13.4	0.1		0.0		
Approach LOS	B					
Intersection Summary						
Average Delay	0.3					
Intersection Capacity Utilization	31.0%			ICU Level of Service	A	
Analysis Period (min)	15					

HCM Unsignalized Intersection Capacity Analysis
3: Tripp Ave & Moira St W

















Wilson Avenue
BG (2034) - AM



Movement	EBT	EBR	WBL	WBT	NBL	NBR
Lane Configurations	→			←	←	↘
Traffic Volume (veh/h)	416	7	18	398	1	30
Future Volume (Veh/h)	416	7	18	398	1	30
Sign Control	Free			Free	Stop	
Grade	0%			0%	0%	
Peak Hour Factor	0.92	0.92	0.92	0.92	0.92	0.92
Hourly flow rate (vph)	452	8	20	433	1	33
Pedestrians						
Lane Width (m)						
Walking Speed (m/s)						
Percent Blockage						
Right turn flare (veh)						
Median type	None		None			
Median storage (veh)						
Upstream signal (m)						
pX, platoon unblocked						
vC, conflicting volume			460		929	456
vC1, stage 1 conf vol						
vC2, stage 2 conf vol						
vCu, unblocked vol			460		929	456
tC, single (s)			4.1		6.4	6.2
tC, 2 stage (s)						
tF (s)			2.2		3.5	3.3
p0 queue free %			98		100	95
cM capacity (veh/h)			1101		292	604
Direction, Lane #	EB 1	WB 1	NB 1			
Volume Total	460	453	34			
Volume Left	0	20	1			
Volume Right	8	0	33			
cSH	1700	1101	586			
Volume to Capacity	0.27	0.02	0.06			
Queue Length 95th (m)	0.0	0.4	1.4			
Control Delay (s)	0.0	0.6	11.5			
Lane LOS			A			B
Approach Delay (s)	0.0	0.6	11.5			
Approach LOS			B			
Intersection Summary						
Average Delay			0.7			
Intersection Capacity Utilization			45.6%	ICU Level of Service	A	
Analysis Period (min)			15			

HCM Unsignalized Intersection Capacity Analysis
4: Elgin St/Driveway & Moira St W

Wilson Avenue
BG (2034) - AM

												
Movement	EBL	EBT	EBR	WBL	WBT	WBR	NBL	NBT	NBR	SBL	SBT	SBR
Lane Configurations												
Traffic Volume (veh/h)	0	450	3	7	401	22	3	0	10	10	0	4
Future Volume (Veh/h)	0	450	3	7	401	22	3	0	10	10	0	4
Sign Control		Free			Free			Stop			Stop	
Grade		0%			0%			0%			0%	
Peak Hour Factor	0.92	0.92	0.92	0.92	0.92	0.92	0.92	0.92	0.92	0.92	0.92	0.92
Hourly flow rate (vph)	0	489	3	8	436	24	3	0	11	11	0	4
Pedestrians												
Lane Width (m)												
Walking Speed (m/s)												
Percent Blockage												
Right turn flare (veh)												
Median type	None				None							
Median storage (veh)												
Upstream signal (m)												
pX, platoon unblocked												
vC, conflicting volume	460			492			958	966	490	966	956	448
vC1, stage 1 conf vol												
vC2, stage 2 conf vol												
vCu, unblocked vol	460			492			958	966	490	966	956	448
tC, single (s)	4.1			4.1			7.1	6.5	6.2	7.1	6.5	6.2
tC, 2 stage (s)												
tF (s)	2.2			2.2			3.5	4.0	3.3	3.5	4.0	3.3
p0 queue free %	100			99			99	100	98	95	100	99
cM capacity (veh/h)	1101			1071			234	252	578	228	256	611
Direction, Lane #	EB 1	WB 1	NB 1	SB 1								
Volume Total	492	468	14	15								
Volume Left	0	8	3	11								
Volume Right	3	24	11	4								
cSH	1101	1071	439	274								
Volume to Capacity	0.00	0.01	0.03	0.05								
Queue Length 95th (m)	0.0	0.2	0.7	1.3								
Control Delay (s)	0.0	0.2	13.5	18.9								
Lane LOS		A	B	C								
Approach Delay (s)	0.0	0.2	13.5	18.9								
Approach LOS			B	C								
Intersection Summary												
Average Delay			0.6									
Intersection Capacity Utilization			38.1%	ICU Level of Service	A							
Analysis Period (min)			15									

HCM Unsignalized Intersection Capacity Analysis
 1: Palmer Rd & Bogart Cres (N)

Wilson Avenue
 Background (2034) - PM



Movement	EBL	EBR	NBL	NBT	SBT	SBR
Lane Configurations						
Traffic Volume (veh/h)	5	5	7	166	249	10
Future Volume (Veh/h)	5	5	7	166	249	10
Sign Control	Stop			Free	Free	
Grade	0%			0%	0%	
Peak Hour Factor	0.92	0.92	0.92	0.92	0.92	0.92
Hourly flow rate (vph)	5	5	8	180	271	11
Pedestrians						
Lane Width (m)						
Walking Speed (m/s)						
Percent Blockage						
Right turn flare (veh)						
Median type				None	None	
Median storage veh						
Upstream signal (m)						
pX, platoon unblocked						
vC, conflicting volume	472	276	282			
vC1, stage 1 conf vol						
vC2, stage 2 conf vol						
vCu, unblocked vol	472	276	282			
tC, single (s)	6.4	6.2	4.1			
tC, 2 stage (s)						
tF (s)	3.5	3.3	2.2			
p0 queue free %	99	99	99			
cM capacity (veh/h)	547	762	1280			
Direction, Lane #	EB 1	NB 1	SB 1			
Volume Total	10	188	282			
Volume Left	5	8	0			
Volume Right	5	0	11			
cSH	637	1280	1700			
Volume to Capacity	0.02	0.01	0.17			
Queue Length 95th (m)	0.4	0.1	0.0			
Control Delay (s)	10.7	0.4	0.0			
Lane LOS	B	A				
Approach Delay (s)	10.7	0.4	0.0			
Approach LOS	B					
Intersection Summary						
Average Delay			0.4			
Intersection Capacity Utilization			24.4%	ICU Level of Service	A	
Analysis Period (min)			15			

HCM Unsignalized Intersection Capacity Analysis
2: Sidney St & Wilson Ave

Wilson Avenue
Background (2034) - PM



Movement	EBL	EBR	NBL	NBT	SBT	SBR
Lane Configurations						
Traffic Volume (veh/h)	12	4	4	1068	756	10
Future Volume (Veh/h)	12	4	4	1068	756	10
Sign Control	Stop			Free	Free	
Grade	0%			0%	0%	
Peak Hour Factor	0.92	0.92	0.92	0.92	0.92	0.92
Hourly flow rate (vph)	13	4	4	1161	822	11
Pedestrians						
Lane Width (m)						
Walking Speed (m/s)						
Percent Blockage						
Right turn flare (veh)						
Median type				None	None	
Median storage veh						
Upstream signal (m)						
pX, platoon unblocked						
vC, conflicting volume	1416	416	833			
vC1, stage 1 conf vol						
vC2, stage 2 conf vol						
vCu, unblocked vol	1416	416	833			
tC, single (s)	6.8	6.9	4.1			
tC, 2 stage (s)						
tF (s)	3.5	3.3	2.2			
p0 queue free %	90	99	99			
cM capacity (veh/h)	128	585	796			
Direction, Lane #	EB 1	NB 1	NB 2	SB 1	SB 2	
Volume Total	17	391	774	548	285	
Volume Left	13	4	0	0	0	
Volume Right	4	0	0	0	11	
cSH	156	796	1700	1700	1700	
Volume to Capacity	0.11	0.01	0.46	0.32	0.17	
Queue Length 95th (m)	2.7	0.1	0.0	0.0	0.0	
Control Delay (s)	30.8	0.2	0.0	0.0	0.0	
Lane LOS	D	A				
Approach Delay (s)	30.8	0.1		0.0		
Approach LOS	D					
Intersection Summary						
Average Delay	0.3					
Intersection Capacity Utilization	42.3%			ICU Level of Service	A	
Analysis Period (min)	15					

HCM Unsignalized Intersection Capacity Analysis

3: Tripp Ave & Moira St W

Wilson Avenue
Background (2034) - PM

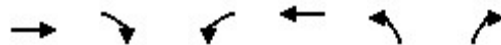

Movement	EBT	EBR	WBL	WBT	NBL	NBR
Lane Configurations	→			←	↔	
Traffic Volume (veh/h)	499	7	55	586	3	49
Future Volume (Veh/h)	499	7	55	586	3	49
Sign Control	Free			Free	Stop	
Grade	0%			0%	0%	
Peak Hour Factor	0.92	0.92	0.92	0.92	0.92	0.92
Hourly flow rate (vph)	542	8	60	637	3	53
Pedestrians						
Lane Width (m)						
Walking Speed (m/s)						
Percent Blockage						
Right turn flare (veh)						
Median type	None		None			
Median storage (veh)						
Upstream signal (m)						
pX, platoon unblocked						
vC, conflicting volume			550		1303	546
vC1, stage 1 conf vol						
vC2, stage 2 conf vol						
vCu, unblocked vol			550		1303	546
tC, single (s)			4.1		6.4	6.2
tC, 2 stage (s)						
tF (s)			2.2		3.5	3.3
p0 queue free %			94		98	90
cM capacity (veh/h)			1020		167	538
Direction, Lane #	EB 1	WB 1	NB 1			
Volume Total	550	697	56			
Volume Left	0	60	3			
Volume Right	8	0	53			
cSH	1700	1020	480			
Volume to Capacity	0.32	0.06	0.12			
Queue Length 95th (m)	0.0	1.4	3.0			
Control Delay (s)	0.0	1.5	13.5			
Lane LOS		A	B			
Approach Delay (s)	0.0	1.5	13.5			
Approach LOS			B			
Intersection Summary						
Average Delay			1.4			
Intersection Capacity Utilization			73.9%	ICU Level of Service	D	
Analysis Period (min)			15			

HCM Unsignalized Intersection Capacity Analysis
4: Elgin St/Driveway & Moira St W

Wilson Avenue
Background (2034) - PM



















Movement	EBL	EBT	EBR	WBL	WBT	WBR	NBL	NBT	NBR	SBL	SBT	SBR
Lane Configurations		↕			↕			↕			↕	
Traffic Volume (veh/h)	5	599	3	16	588	41	5	0	16	22	0	12
Future Volume (Veh/h)	5	599	3	16	588	41	5	0	16	22	0	12
Sign Control		Free			Free			Stop			Stop	
Grade		0%			0%			0%			0%	
Peak Hour Factor	0.92	0.92	0.92	0.92	0.92	0.92	0.92	0.92	0.92	0.92	0.92	0.92
Hourly flow rate (vph)	5	651	3	17	639	45	5	0	17	24	0	13
Pedestrians												
Lane Width (m)												
Walking Speed (m/s)												
Percent Blockage												
Right turn flare (veh)												
Median type	None				None							
Median storage (veh)												
Upstream signal (m)												
pX, platoon unblocked												
vC, conflicting volume	684			654			1371	1380	652	1375	1360	662
vC1, stage 1 conf vol												
vC2, stage 2 conf vol												
vCu, unblocked vol	684			654			1371	1380	652	1375	1360	662
tC, single (s)	4.1			4.1			7.1	6.5	6.2	7.1	6.5	6.2
tC, 2 stage (s)												
tF (s)	2.2			2.2			3.5	4.0	3.3	3.5	4.0	3.3
p0 queue free %	99			98			96	100	96	79	100	97
cM capacity (veh/h)	909			933			118	141	468	116	145	462
Direction, Lane #												
	EB 1	WB 1	NB 1	SB 1								
Volume Total	659	701	22	37								
Volume Left	5	17	5	24								
Volume Right	3	45	17	13								
cSH	909	933	279	157								
Volume to Capacity	0.01	0.02	0.08	0.23								
Queue Length 95th (m)	0.1	0.4	1.9	6.6								
Control Delay (s)	0.1	0.5	19.0	34.7								
Lane LOS	A	A	C	D								
Approach Delay (s)	0.1	0.5	19.0	34.7								
Approach LOS			C	D								
Intersection Summary												
Average Delay			1.5									
Intersection Capacity Utilization			55.1%	ICU Level of Service	B							
Analysis Period (min)			15									

Appendix F – Synchro Analysis Output – Total Traffic Volumes

HCM Unsignalized Intersection Capacity Analysis
 1: Palmer Rd & Bogart Cres (N)/Wilson Ave ext.

Wilson Avenue
 Total (2029) - AM

												
Movement	EBL	EBT	EBR	WBL	WBT	WBR	NBL	NBT	NBR	SBL	SBT	SBR
Lane Configurations												
Traffic Volume (veh/h)	11	0	8	21	0	21	0	105	7	7	106	4
Future Volume (Veh/h)	11	0	8	21	0	21	0	105	7	7	106	4
Sign Control		Stop			Stop			Free			Free	
Grade		0%			0%			0%			0%	
Peak Hour Factor	0.92	0.92	0.92	0.92	0.92	0.92	0.92	0.92	0.92	0.92	0.92	0.92
Hourly flow rate (vph)	12	0	9	23	0	23	0	114	8	8	115	4
Pedestrians												
Lane Width (m)												
Walking Speed (m/s)												
Percent Blockage												
Right turn flare (veh)												
Median type								None			None	
Median storage veh												
Upstream signal (m)												
pX, platoon unblocked												
vC, conflicting volume	274	255	117	260	253	118	119			122		
vC1, stage 1 conf vol												
vC2, stage 2 conf vol												
vCu, unblocked vol	274	255	117	260	253	118	119			122		
tC, single (s)	7.1	6.5	6.2	7.1	6.5	6.2	4.1			4.1		
tC, 2 stage (s)												
tF (s)	3.5	4.0	3.3	3.5	4.0	3.3	2.2			2.2		
p0 queue free %	98	100	99	97	100	98	100			99		
cM capacity (veh/h)	659	645	935	683	647	934	1469			1465		
Direction, Lane #	EB 1	WB 1	NB 1	SB 1								
Volume Total	21	46	122	127								
Volume Left	12	23	0	8								
Volume Right	9	23	8	4								
cSH	754	789	1469	1465								
Volume to Capacity	0.03	0.06	0.00	0.01								
Queue Length 95th (m)	0.7	1.4	0.0	0.1								
Control Delay (s)	9.9	9.8	0.0	0.5								
Lane LOS	A	A		A								
Approach Delay (s)	9.9	9.8	0.0	0.5								
Approach LOS	A	A										
Intersection Summary												
Average Delay			2.3									
Intersection Capacity Utilization			21.6%		ICU Level of Service				A			
Analysis Period (min)			15									

HCM Unsignalized Intersection Capacity Analysis
2: Sidney St & Wilson Ave

Wilson Avenue
Total (2029) - AM



Movement	EBL	EBR	NBL	NBT	SBT	SBR
Lane Configurations						
Traffic Volume (veh/h)	25	32	14	543	558	28
Future Volume (Veh/h)	25	32	14	543	558	28
Sign Control	Stop			Free	Free	
Grade	0%			0%	0%	
Peak Hour Factor	0.92	0.92	0.92	0.92	0.92	0.92
Hourly flow rate (vph)	27	35	15	590	607	30
Pedestrians						
Lane Width (m)						
Walking Speed (m/s)						
Percent Blockage						
Right turn flare (veh)						
Median type				None	None	
Median storage (veh)						
Upstream signal (m)						
pX, platoon unblocked						
vC, conflicting volume	947	318	637			
vC1, stage 1 conf vol						
vC2, stage 2 conf vol						
vCu, unblocked vol	947	318	637			
tC, single (s)	6.8	6.9	4.1			
tC, 2 stage (s)						
tF (s)	3.5	3.3	2.2			
p0 queue free %	89	95	98			
cM capacity (veh/h)	255	677	943			
Direction, Lane #	EB 1	NB 1	NB 2	SB 1	SB 2	
Volume Total	62	212	393	405	232	
Volume Left	27	15	0	0	0	
Volume Right	35	0	0	0	30	
cSH	394	943	1700	1700	1700	
Volume to Capacity	0.16	0.02	0.23	0.24	0.14	
Queue Length 95th (m)	4.2	0.4	0.0	0.0	0.0	
Control Delay (s)	15.8	0.8	0.0	0.0	0.0	
Lane LOS	C	A				
Approach Delay (s)	15.8	0.3		0.0		
Approach LOS	C					
Intersection Summary						
Average Delay			0.9			
Intersection Capacity Utilization			35.1%	ICU Level of Service	A	
Analysis Period (min)			15			

HCM Unsignalized Intersection Capacity Analysis
3: Tripp Ave & Moira St W



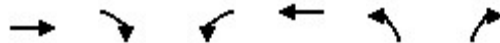













Wilson Avenue
Total (2029) - AM



Movement	EBT	EBR	WBL	WBT	NBL	NBR
Lane Configurations	↔			↔	↔	
Traffic Volume (veh/h)	393	7	18	372	1	30
Future Volume (Veh/h)	393	7	18	372	1	30
Sign Control	Free			Free	Stop	
Grade	0%			0%	0%	
Peak Hour Factor	0.92	0.92	0.92	0.92	0.92	0.92
Hourly flow rate (vph)	427	8	20	404	1	33
Pedestrians						
Lane Width (m)						
Walking Speed (m/s)						
Percent Blockage						
Right turn flare (veh)						
Median type	None		None			
Median storage (veh)						
Upstream signal (m)						
pX, platoon unblocked						
vC, conflicting volume			435		875	431
vC1, stage 1 conf vol						
vC2, stage 2 conf vol						
vCu, unblocked vol			435		875	431
tC, single (s)			4.1		6.4	6.2
tC, 2 stage (s)						
tF (s)			2.2		3.5	3.3
p0 queue free %			98		100	95
cM capacity (veh/h)			1125		314	624
Direction, Lane #	EB 1	WB 1	NB 1			
Volume Total	435	424	34			
Volume Left	0	20	1			
Volume Right	8	0	33			
cSH	1700	1125	607			
Volume to Capacity	0.26	0.02	0.06			
Queue Length 95th (m)	0.0	0.4	1.4			
Control Delay (s)	0.0	0.6	11.3			
Lane LOS		A	B			
Approach Delay (s)	0.0	0.6	11.3			
Approach LOS			B			
Intersection Summary						
Average Delay			0.7			
Intersection Capacity Utilization			44.2%	ICU Level of Service	A	
Analysis Period (min)			15			

















HCM Unsignalized Intersection Capacity Analysis
4: Elgin St/Driveway & Moira St W

Wilson Avenue
Total (2029) - AM

												
Movement	EBL	EBT	EBR	WBL	WBT	WBR	NBL	NBT	NBR	SBL	SBT	SBR
Lane Configurations												
Traffic Volume (veh/h)	0	424	3	7	375	22	3	0	10	10	0	4
Future Volume (Veh/h)	0	424	3	7	375	22	3	0	10	10	0	4
Sign Control		Free			Free			Stop			Stop	
Grade		0%			0%			0%			0%	
Peak Hour Factor	0.92	0.92	0.92	0.92	0.92	0.92	0.92	0.92	0.92	0.92	0.92	0.92
Hourly flow rate (vph)	0	461	3	8	408	24	3	0	11	11	0	4
Pedestrians												
Lane Width (m)												
Walking Speed (m/s)												
Percent Blockage												
Right turn flare (veh)												
Median type		None			None							
Median storage (veh)												
Upstream signal (m)												
pX, platoon unblocked												
vC, conflicting volume	432			464			902	910	462	910	900	420
vC1, stage 1 conf vol												
vC2, stage 2 conf vol												
vCu, unblocked vol	432			464			902	910	462	910	900	420
tC, single (s)	4.1			4.1			7.1	6.5	6.2	7.1	6.5	6.2
tC, 2 stage (s)												
tF (s)	2.2			2.2			3.5	4.0	3.3	3.5	4.0	3.3
p0 queue free %	100			99			99	100	98	96	100	99
cM capacity (veh/h)	1128			1097			255	272	599	250	276	633
Direction, Lane #	EB 1	WB 1	NB 1	SB 1								
Volume Total	464	440	14	15								
Volume Left	0	8	3	11								
Volume Right	3	24	11	4								
cSH	1128	1097	465	298								
Volume to Capacity	0.00	0.01	0.03	0.05								
Queue Length 95th (m)	0.0	0.2	0.7	1.2								
Control Delay (s)	0.0	0.2	13.0	17.7								
Lane LOS		A	B	C								
Approach Delay (s)	0.0	0.2	13.0	17.7								
Approach LOS			B	C								
Intersection Summary												
Average Delay			0.6									
Intersection Capacity Utilization			36.7%		ICU Level of Service				A			
Analysis Period (min)			15									

HCM Unsignalized Intersection Capacity Analysis
 1: Palmer Rd & Bogart Cres (N)

Wilson Avenue
 Total (2029) - PM

												
Movement	EBL	EBT	EBR	WBL	WBT	WBR	NBL	NBT	NBR	SBL	SBT	SBR
Lane Configurations												
Traffic Volume (veh/h)	5	0	5	12	0	13	7	155	21	21	232	10
Future Volume (Veh/h)	5	0	5	12	0	13	7	155	21	21	232	10
Sign Control		Stop			Stop			Free			Free	
Grade		0%			0%			0%			0%	
Peak Hour Factor	0.92	0.92	0.92	0.92	0.92	0.92	0.92	0.92	0.92	0.92	0.92	0.92
Hourly flow rate (vph)	5	0	5	13	0	14	8	168	23	23	252	11
Pedestrians												
Lane Width (m)												
Walking Speed (m/s)												
Percent Blockage												
Right turn flare (veh)												
Median type								None			None	
Median storage (veh)												
Upstream signal (m)												
pX, platoon unblocked												
vC, conflicting volume	513	510	258	504	504	180	263			191		
vC1, stage 1 conf vol												
vC2, stage 2 conf vol												
vCu, unblocked vol	513	510	258	504	504	180	263			191		
tC, single (s)	7.1	6.5	6.2	7.1	6.5	6.2	4.1			4.1		
tC, 2 stage (s)												
tF (s)	3.5	4.0	3.3	3.5	4.0	3.3	2.2			2.2		
p0 queue free %	99	100	99	97	100	98	99			98		
cM capacity (veh/h)	456	456	781	467	459	863	1301			1383		
Direction, Lane #	EB 1	WB 1	NB 1	SB 1								
Volume Total	10	27	199	286								
Volume Left	5	13	8	23								
Volume Right	5	14	23	11								
cSH	576	613	1301	1383								
Volume to Capacity	0.02	0.04	0.01	0.02								
Queue Length 95th (m)	0.4	1.0	0.1	0.4								
Control Delay (s)	11.4	11.1	0.4	0.8								
Lane LOS	B	B	A	A								
Approach Delay (s)	11.4	11.1	0.4	0.8								
Approach LOS	B	B										
Intersection Summary												
Average Delay			1.3									
Intersection Capacity Utilization			31.3%		ICU Level of Service				A			
Analysis Period (min)			15									

HCM Unsignalized Intersection Capacity Analysis
 2: Sidney St & Wilson Ave

Wilson Avenue
 Total (2029) - PM



Movement	EBL	EBR	NBL	NBT	SBT	SBR
Lane Configurations						
Traffic Volume (veh/h)	25	17	26	1000	712	32
Future Volume (Veh/h)	25	17	26	1000	712	32
Sign Control	Stop			Free	Free	
Grade	0%			0%	0%	
Peak Hour Factor	0.92	0.92	0.92	0.92	0.92	0.92
Hourly flow rate (vph)	27	18	28	1087	774	35
Pedestrians						
Lane Width (m)						
Walking Speed (m/s)						
Percent Blockage						
Right turn flare (veh)						
Median type				None	None	
Median storage veh						
Upstream signal (m)						
pX, platoon unblocked						
vC, conflicting volume	1391	404	809			
vC1, stage 1 conf vol						
vC2, stage 2 conf vol						
vCu, unblocked vol	1391	404	809			
tC, single (s)	6.8	6.9	4.1			
tC, 2 stage (s)						
tF (s)	3.5	3.3	2.2			
p0 queue free %	79	97	97			
cM capacity (veh/h)	129	596	812			
Direction, Lane #	EB 1	NB 1	NB 2	SB 1	SB 2	
Volume Total	45	390	725	516	293	
Volume Left	27	28	0	0	0	
Volume Right	18	0	0	0	35	
cSH	187	812	1700	1700	1700	
Volume to Capacity	0.24	0.03	0.43	0.30	0.17	
Queue Length 95th (m)	6.9	0.8	0.0	0.0	0.0	
Control Delay (s)	30.2	1.1	0.0	0.0	0.0	
Lane LOS	D	A				
Approach Delay (s)	30.2	0.4		0.0		
Approach LOS	D					
Intersection Summary						
Average Delay	0.9					
Intersection Capacity Utilization	56.3%			ICU Level of Service	B	
Analysis Period (min)	15					

HCM Unsignalized Intersection Capacity Analysis
3: Tripp Ave & Moira St W

















Wilson Avenue
Total (2029) - PM



Movement	EBT	EBR	WBL	WBT	NBL	NBR
Lane Configurations	↩			↩	↩	
Traffic Volume (veh/h)	468	7	55	560	3	49
Future Volume (Veh/h)	468	7	55	560	3	49
Sign Control	Free			Free	Stop	
Grade	0%			0%	0%	
Peak Hour Factor	0.92	0.92	0.92	0.92	0.92	0.92
Hourly flow rate (vph)	509	8	60	609	3	53
Pedestrians						
Lane Width (m)						
Walking Speed (m/s)						
Percent Blockage						
Right turn flare (veh)						
Median type	None		None			
Median storage (veh)						
Upstream signal (m)						
pX, platoon unblocked						
vC, conflicting volume			517		1242	513
vC1, stage 1 conf vol						
vC2, stage 2 conf vol						
vCu, unblocked vol			517		1242	513
tC, single (s)			4.1		6.4	6.2
tC, 2 stage (s)						
tF (s)			2.2		3.5	3.3
p0 queue free %			94		98	91
cM capacity (veh/h)			1049		182	561
Direction, Lane #	EB 1	WB 1	NB 1			
Volume Total	517	669	56			
Volume Left	0	60	3			
Volume Right	8	0	53			
cSH	1700	1049	505			
Volume to Capacity	0.30	0.06	0.11			
Queue Length 95th (m)	0.0	1.4	2.8			
Control Delay (s)	0.0	1.5	13.0			
Lane LOS		A	B			
Approach Delay (s)	0.0	1.5	13.0			
Approach LOS			B			
Intersection Summary						
Average Delay			1.4			
Intersection Capacity Utilization			70.9%	ICU Level of Service	C	
Analysis Period (min)			15			

















HCM Unsignalized Intersection Capacity Analysis
4: Elgin St/Driveway & Moira St W

Wilson Avenue
Total (2029) - PM

												
Movement	EBL	EBT	EBR	WBL	WBT	WBR	NBL	NBT	NBR	SBL	SBT	SBR
Lane Configurations												
Traffic Volume (veh/h)	5	560	3	16	553	41	5	0	16	22	0	12
Future Volume (Veh/h)	5	560	3	16	553	41	5	0	16	22	0	12
Sign Control		Free			Free			Stop			Stop	
Grade		0%			0%			0%			0%	
Peak Hour Factor	0.92	0.92	0.92	0.92	0.92	0.92	0.92	0.92	0.92	0.92	0.92	0.92
Hourly flow rate (vph)	5	609	3	17	601	45	5	0	17	24	0	13
Pedestrians												
Lane Width (m)												
Walking Speed (m/s)												
Percent Blockage												
Right turn flare (veh)												
Median type		None			None							
Median storage (veh)												
Upstream signal (m)												
pX, platoon unblocked												
vC, conflicting volume	646			612			1291	1300	610	1295	1280	624
vC1, stage 1 conf vol												
vC2, stage 2 conf vol												
vCu, unblocked vol	646			612			1291	1300	610	1295	1280	624
tC, single (s)	4.1			4.1			7.1	6.5	6.2	7.1	6.5	6.2
tC, 2 stage (s)												
tF (s)	2.2			2.2			3.5	4.0	3.3	3.5	4.0	3.3
p0 queue free %	99			98			96	100	97	82	100	97
cM capacity (veh/h)	939			967			134	157	494	132	162	486
Direction, Lane #	EB 1	WB 1	NB 1	SB 1								
Volume Total	617	663	22	37								
Volume Left	5	17	5	24								
Volume Right	3	45	17	13								
cSH	939	967	307	178								
Volume to Capacity	0.01	0.02	0.07	0.21								
Queue Length 95th (m)	0.1	0.4	1.7	5.8								
Control Delay (s)	0.1	0.5	17.6	30.5								
Lane LOS	A	A	C	D								
Approach Delay (s)	0.1	0.5	17.6	30.5								
Approach LOS			C	D								
Intersection Summary												
Average Delay			1.4									
Intersection Capacity Utilization			53.1%		ICU Level of Service				A			
Analysis Period (min)			15									

HCM Unsignalized Intersection Capacity Analysis
 1: Palmer Rd & Bogart Cres (N)/Wilson Ave ext.

Wilson Avenue
 Total (2034) - AM

												
Movement	EBL	EBT	EBR	WBL	WBT	WBR	NBL	NBT	NBR	SBL	SBT	SBR
Lane Configurations												
Traffic Volume (veh/h)	11	0	8	21	0	21	0	113	7	7	113	4
Future Volume (Veh/h)	11	0	8	21	0	21	0	113	7	7	113	4
Sign Control		Stop			Stop			Free			Free	
Grade		0%			0%			0%			0%	
Peak Hour Factor	0.92	0.92	0.92	0.92	0.92	0.92	0.92	0.92	0.92	0.92	0.92	0.92
Hourly flow rate (vph)	12	0	9	23	0	23	0	123	8	8	123	4
Pedestrians												
Lane Width (m)												
Walking Speed (m/s)												
Percent Blockage												
Right turn flare (veh)												
Median type								None			None	
Median storage (veh)												
Upstream signal (m)												
pX, platoon unblocked												
vC, conflicting volume	291	272	125	277	270	127	127			131		
vC1, stage 1 conf vol												
vC2, stage 2 conf vol												
vCu, unblocked vol	291	272	125	277	270	127	127			131		
tC, single (s)	7.1	6.5	6.2	7.1	6.5	6.2	4.1			4.1		
tC, 2 stage (s)												
tF (s)	3.5	4.0	3.3	3.5	4.0	3.3	2.2			2.2		
p0 queue free %	98	100	99	97	100	98	100			99		
cM capacity (veh/h)	642	631	926	666	633	923	1459			1454		
Direction, Lane #	EB 1	WB 1	NB 1	SB 1								
Volume Total	21	46	131	135								
Volume Left	12	23	0	8								
Volume Right	9	23	8	4								
cSH	739	774	1459	1454								
Volume to Capacity	0.03	0.06	0.00	0.01								
Queue Length 95th (m)	0.7	1.4	0.0	0.1								
Control Delay (s)	10.0	9.9	0.0	0.5								
Lane LOS	B	A		A								
Approach Delay (s)	10.0	9.9	0.0	0.5								
Approach LOS	B	A										
Intersection Summary												
Average Delay			2.2									
Intersection Capacity Utilization			21.9%		ICU Level of Service				A			
Analysis Period (min)			15									

HCM Unsignalized Intersection Capacity Analysis
2: Sidney St & Wilson Ave

Wilson Avenue
Total (2034) - AM



Movement	EBL	EBR	NBL	NBT	SBT	SBR
Lane Configurations						
Traffic Volume (veh/h)	25	32	14	580	596	28
Future Volume (Veh/h)	25	32	14	580	596	28
Sign Control	Stop			Free	Free	
Grade	0%			0%	0%	
Peak Hour Factor	0.92	0.92	0.92	0.92	0.92	0.92
Hourly flow rate (vph)	27	35	15	630	648	30
Pedestrians						
Lane Width (m)						
Walking Speed (m/s)						
Percent Blockage						
Right turn flare (veh)						
Median type				None	None	
Median storage (veh)						
Upstream signal (m)						
pX, platoon unblocked						
vC, conflicting volume	1008	339	678			
vC1, stage 1 conf vol						
vC2, stage 2 conf vol						
vCu, unblocked vol	1008	339	678			
tC, single (s)	6.8	6.9	4.1			
tC, 2 stage (s)						
tF (s)	3.5	3.3	2.2			
p0 queue free %	88	95	98			
cM capacity (veh/h)	233	657	910			
Direction, Lane #	EB 1	NB 1	NB 2	SB 1	SB 2	
Volume Total	62	225	420	432	246	
Volume Left	27	15	0	0	0	
Volume Right	35	0	0	0	30	
cSH	367	910	1700	1700	1700	
Volume to Capacity	0.17	0.02	0.25	0.25	0.14	
Queue Length 95th (m)	4.6	0.4	0.0	0.0	0.0	
Control Delay (s)	16.8	0.8	0.0	0.0	0.0	
Lane LOS	C	A				
Approach Delay (s)	16.8	0.3		0.0		
Approach LOS	C					
Intersection Summary						
Average Delay	0.9					
Intersection Capacity Utilization	36.1%			ICU Level of Service	A	
Analysis Period (min)	15					

HCM Unsignalized Intersection Capacity Analysis
3: Tripp Ave & Moira St W



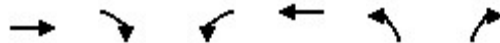













Wilson Avenue
Total (2034) - AM



Movement	EBT	EBR	WBL	WBT	NBL	NBR
Lane Configurations	→			←	←	→
Traffic Volume (veh/h)	421	12	18	400	1	30
Future Volume (Veh/h)	421	12	18	400	1	30
Sign Control	Free			Free	Stop	
Grade	0%			0%	0%	
Peak Hour Factor	0.92	0.92	0.92	0.92	0.92	0.92
Hourly flow rate (vph)	458	13	20	435	1	33
Pedestrians						
Lane Width (m)						
Walking Speed (m/s)						
Percent Blockage						
Right turn flare (veh)						
Median type	None			None		
Median storage (veh)						
Upstream signal (m)						
pX, platoon unblocked						
vC, conflicting volume			471		940	464
vC1, stage 1 conf vol						
vC2, stage 2 conf vol						
vCu, unblocked vol			471		940	464
tC, single (s)			4.1		6.4	6.2
tC, 2 stage (s)						
tF (s)			2.2		3.5	3.3
p0 queue free %			98		100	94
cM capacity (veh/h)			1091		287	598
Direction, Lane #	EB 1	WB 1	NB 1			
Volume Total	471	455	34			
Volume Left	0	20	1			
Volume Right	13	0	33			
cSH	1700	1091	579			
Volume to Capacity	0.28	0.02	0.06			
Queue Length 95th (m)	0.0	0.4	1.4			
Control Delay (s)	0.0	0.6	11.6			
Lane LOS		A	B			
Approach Delay (s)	0.0	0.6	11.6			
Approach LOS			B			
Intersection Summary						
Average Delay			0.7			
Intersection Capacity Utilization			45.7%	ICU Level of Service	A	
Analysis Period (min)			15			

HCM Unsignalized Intersection Capacity Analysis
4: Elgin St/Driveway & Moira St W

















Wilson Avenue
Total (2034) - AM

												
Movement	EBL	EBT	EBR	WBL	WBT	WBR	NBL	NBT	NBR	SBL	SBT	SBR
Lane Configurations												
Traffic Volume (veh/h)	0	455	3	7	403	22	3	0	10	10	0	4
Future Volume (Veh/h)	0	455	3	7	403	22	3	0	10	10	0	4
Sign Control		Free			Free			Stop			Stop	
Grade		0%			0%			0%			0%	
Peak Hour Factor	0.92	0.92	0.92	0.92	0.92	0.92	0.92	0.92	0.92	0.92	0.92	0.92
Hourly flow rate (vph)	0	495	3	8	438	24	3	0	11	11	0	4
Pedestrians												
Lane Width (m)												
Walking Speed (m/s)												
Percent Blockage												
Right turn flare (veh)												
Median type		None			None							
Median storage (veh)												
Upstream signal (m)												
pX, platoon unblocked												
vC, conflicting volume	462			498			966	974	496	974	964	450
vC1, stage 1 conf vol												
vC2, stage 2 conf vol												
vCu, unblocked vol	462			498			966	974	496	974	964	450
tC, single (s)	4.1			4.1			7.1	6.5	6.2	7.1	6.5	6.2
tC, 2 stage (s)												
tF (s)	2.2			2.2			3.5	4.0	3.3	3.5	4.0	3.3
p0 queue free %	100			99			99	100	98	95	100	99
cM capacity (veh/h)	1099			1066			231	250	573	226	253	609
Direction, Lane #	EB 1	WB 1	NB 1	SB 1								
Volume Total	498	470	14	15								
Volume Left	0	8	3	11								
Volume Right	3	24	11	4								
cSH	1099	1066	435	271								
Volume to Capacity	0.00	0.01	0.03	0.06								
Queue Length 95th (m)	0.0	0.2	0.8	1.3								
Control Delay (s)	0.0	0.2	13.5	19.1								
Lane LOS		A	B	C								
Approach Delay (s)	0.0	0.2	13.5	19.1								
Approach LOS			B	C								
Intersection Summary												
Average Delay			0.6									
Intersection Capacity Utilization			38.2%	ICU Level of Service	A							
Analysis Period (min)			15									

HCM Unsignalized Intersection Capacity Analysis

1: Palmer Rd & Bogart Cres (N)

Wilson Avenue
Total (2034) - PM

												
Movement	EBL	EBT	EBR	WBL	WBT	WBR	NBL	NBT	NBR	SBL	SBT	SBR
Lane Configurations												
Traffic Volume (veh/h)	5	0	5	12	0	13	7	166	21	21	249	10
Future Volume (Veh/h)	5	0	5	12	0	13	7	166	21	21	249	10
Sign Control		Stop			Stop			Free			Free	
Grade		0%			0%			0%			0%	
Peak Hour Factor	0.92	0.92	0.92	0.92	0.92	0.92	0.92	0.92	0.92	0.92	0.92	0.92
Hourly flow rate (vph)	5	0	5	13	0	14	8	180	23	23	271	11
Pedestrians												
Lane Width (m)												
Walking Speed (m/s)												
Percent Blockage												
Right turn flare (veh)												
Median type												
								None			None	
Median storage veh												
Upstream signal (m)												
pX, platoon unblocked												
vC, conflicting volume	544	542	276	535	536	192	282			203		
vC1, stage 1 conf vol												
vC2, stage 2 conf vol												
vCu, unblocked vol	544	542	276	535	536	192	282			203		
tC, single (s)	7.1	6.5	6.2	7.1	6.5	6.2	4.1			4.1		
tC, 2 stage (s)												
tF (s)	3.5	4.0	3.3	3.5	4.0	3.3	2.2			2.2		
p0 queue free %	99	100	99	97	100	98	99			98		
cM capacity (veh/h)	435	437	762	445	441	850	1280			1369		
Direction, Lane #												
	EB 1	WB 1	NB 1	SB 1								
Volume Total	10	27	211	305								
Volume Left	5	13	8	23								
Volume Right	5	14	23	11								
cSH	554	591	1280	1369								
Volume to Capacity	0.02	0.05	0.01	0.02								
Queue Length 95th (m)	0.4	1.1	0.1	0.4								
Control Delay (s)	11.6	11.4	0.4	0.7								
Lane LOS	B	B	A	A								
Approach Delay (s)	11.6	11.4	0.4	0.7								
Approach LOS	B	B										
Intersection Summary												
Average Delay			1.3									
Intersection Capacity Utilization			32.4%	ICU Level of Service	A							
Analysis Period (min)			15									

HCM Unsignalized Intersection Capacity Analysis
2: Sidney St & Wilson Ave

Wilson Avenue
Total (2034) - PM



Movement	EBL	EBR	NBL	NBT	SBT	SBR
Lane Configurations						
Traffic Volume (veh/h)	25	17	26	1068	756	32
Future Volume (Veh/h)	25	17	26	1068	756	32
Sign Control	Stop			Free	Free	
Grade	0%			0%	0%	
Peak Hour Factor	0.92	0.92	0.92	0.92	0.92	0.92
Hourly flow rate (vph)	27	18	28	1161	822	35
Pedestrians						
Lane Width (m)						
Walking Speed (m/s)						
Percent Blockage						
Right turn flare (veh)						
Median type				None	None	
Median storage (veh)						
Upstream signal (m)						
pX, platoon unblocked						
vC, conflicting volume	1476	428	857			
vC1, stage 1 conf vol						
vC2, stage 2 conf vol						
vCu, unblocked vol	1476	428	857			
tC, single (s)	6.8	6.9	4.1			
tC, 2 stage (s)						
tF (s)	3.5	3.3	2.2			
p0 queue free %	76	97	96			
cM capacity (veh/h)	113	575	779			
Direction, Lane #	EB 1	NB 1	NB 2	SB 1	SB 2	
Volume Total	45	415	774	548	309	
Volume Left	27	28	0	0	0	
Volume Right	18	0	0	0	35	
cSH	166	779	1700	1700	1700	
Volume to Capacity	0.27	0.04	0.46	0.32	0.18	
Queue Length 95th (m)	7.9	0.8	0.0	0.0	0.0	
Control Delay (s)	34.5	1.1	0.0	0.0	0.0	
Lane LOS	D	A				
Approach Delay (s)	34.5	0.4		0.0		
Approach LOS	D					
Intersection Summary						
Average Delay	1.0					
Intersection Capacity Utilization	58.2%			ICU Level of Service	B	
Analysis Period (min)	15					

HCM Unsignalized Intersection Capacity Analysis
3: Tripp Ave & Moira St W

















Wilson Avenue
Total (2034) - PM



Movement	EBT	EBR	WBL	WBT	NBL	NBR
Lane Configurations	→			←	←	↘
Traffic Volume (veh/h)	502	7	55	601	3	49
Future Volume (Veh/h)	502	7	55	601	3	49
Sign Control	Free			Free	Stop	
Grade	0%			0%	0%	
Peak Hour Factor	0.92	0.92	0.92	0.92	0.92	0.92
Hourly flow rate (vph)	546	8	60	653	3	53
Pedestrians						
Lane Width (m)						
Walking Speed (m/s)						
Percent Blockage						
Right turn flare (veh)						
Median type	None		None			
Median storage (veh)						
Upstream signal (m)						
pX, platoon unblocked						
vC, conflicting volume			554		1323	550
vC1, stage 1 conf vol						
vC2, stage 2 conf vol						
vCu, unblocked vol			554		1323	550
tC, single (s)			4.1		6.4	6.2
tC, 2 stage (s)						
tF (s)			2.2		3.5	3.3
p0 queue free %			94		98	90
cM capacity (veh/h)			1016		162	535
Direction, Lane #	EB 1	WB 1	NB 1			
Volume Total	554	713	56			
Volume Left	0	60	3			
Volume Right	8	0	53			
cSH	1700	1016	476			
Volume to Capacity	0.33	0.06	0.12			
Queue Length 95th (m)	0.0	1.4	3.0			
Control Delay (s)	0.0	1.5	13.6			
Lane LOS		A	B			
Approach Delay (s)	0.0	1.5	13.6			
Approach LOS			B			
Intersection Summary						
Average Delay			1.4			
Intersection Capacity Utilization			74.8%	ICU Level of Service	D	
Analysis Period (min)			15			

HCM Unsignalized Intersection Capacity Analysis
4: Elgin St/Driveway & Moira St W

Wilson Avenue
Total (2034) - PM

												
Movement	EBL	EBT	EBR	WBL	WBT	WBR	NBL	NBT	NBR	SBL	SBT	SBR
Lane Configurations												
Traffic Volume (veh/h)	5	602	3	16	593	41	5	0	16	22	0	12
Future Volume (Veh/h)	5	602	3	16	593	41	5	0	16	22	0	12
Sign Control		Free			Free			Stop			Stop	
Grade		0%			0%			0%			0%	
Peak Hour Factor	0.92	0.92	0.92	0.92	0.92	0.92	0.92	0.92	0.92	0.92	0.92	0.92
Hourly flow rate (vph)	5	654	3	17	645	45	5	0	17	24	0	13
Pedestrians												
Lane Width (m)												
Walking Speed (m/s)												
Percent Blockage												
Right turn flare (veh)												
Median type		None			None							
Median storage (veh)												
Upstream signal (m)												
pX, platoon unblocked												
vC, conflicting volume	690			657			1380	1390	656	1384	1368	668
vC1, stage 1 conf vol												
vC2, stage 2 conf vol												
vCu, unblocked vol	690			657			1380	1390	656	1384	1368	668
tC, single (s)	4.1			4.1			7.1	6.5	6.2	7.1	6.5	6.2
tC, 2 stage (s)												
tF (s)	2.2			2.2			3.5	4.0	3.3	3.5	4.0	3.3
p0 queue free %	99			98			96	100	96	79	100	97
cM capacity (veh/h)	905			931			116	139	466	114	143	458
Direction, Lane #	EB 1	WB 1	NB 1	SB 1								
Volume Total	662	707	22	37								
Volume Left	5	17	5	24								
Volume Right	3	45	17	13								
cSH	905	931	276	155								
Volume to Capacity	0.01	0.02	0.08	0.24								
Queue Length 95th (m)	0.1	0.4	2.0	6.7								
Control Delay (s)	0.1	0.5	19.1	35.3								
Lane LOS	A	A	C	E								
Approach Delay (s)	0.1	0.5	19.1	35.3								
Approach LOS			C	E								
Intersection Summary												
Average Delay			1.5									
Intersection Capacity Utilization			55.4%		ICU Level of Service				B			
Analysis Period (min)			15									

Appendix G – MTO Left Turn Analysis

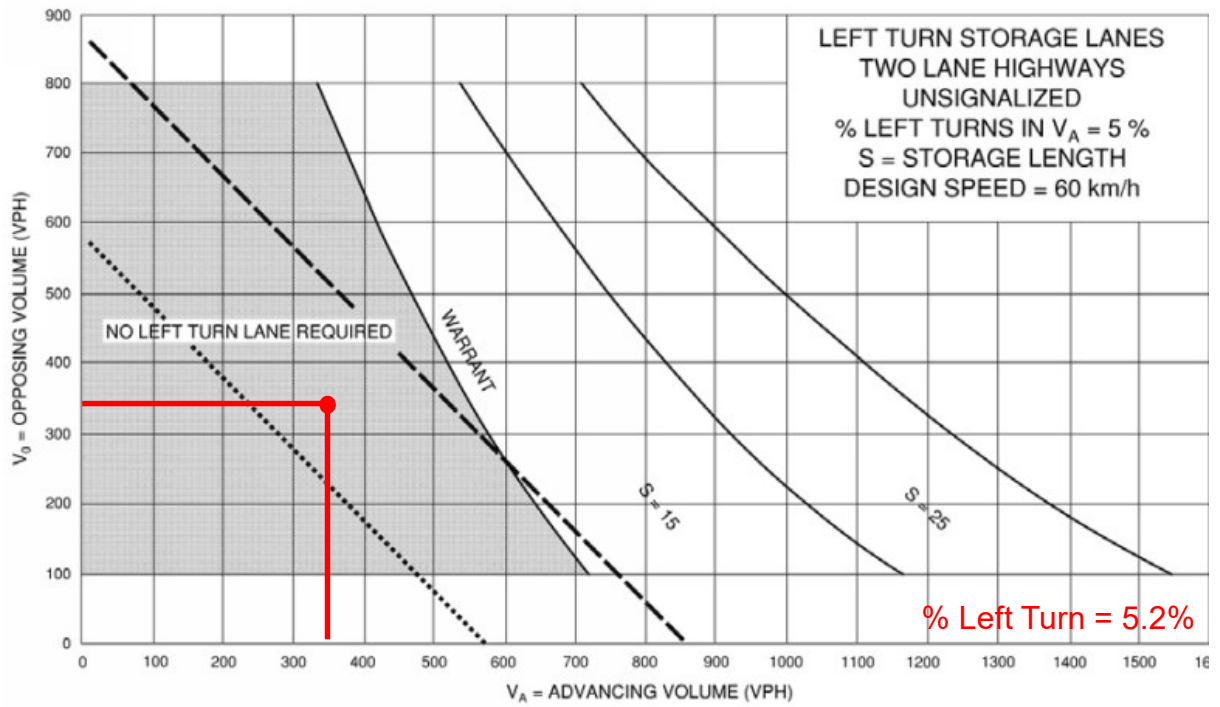

Existing (2022) AM Peak – WB on Moira St W at Tripp Ave

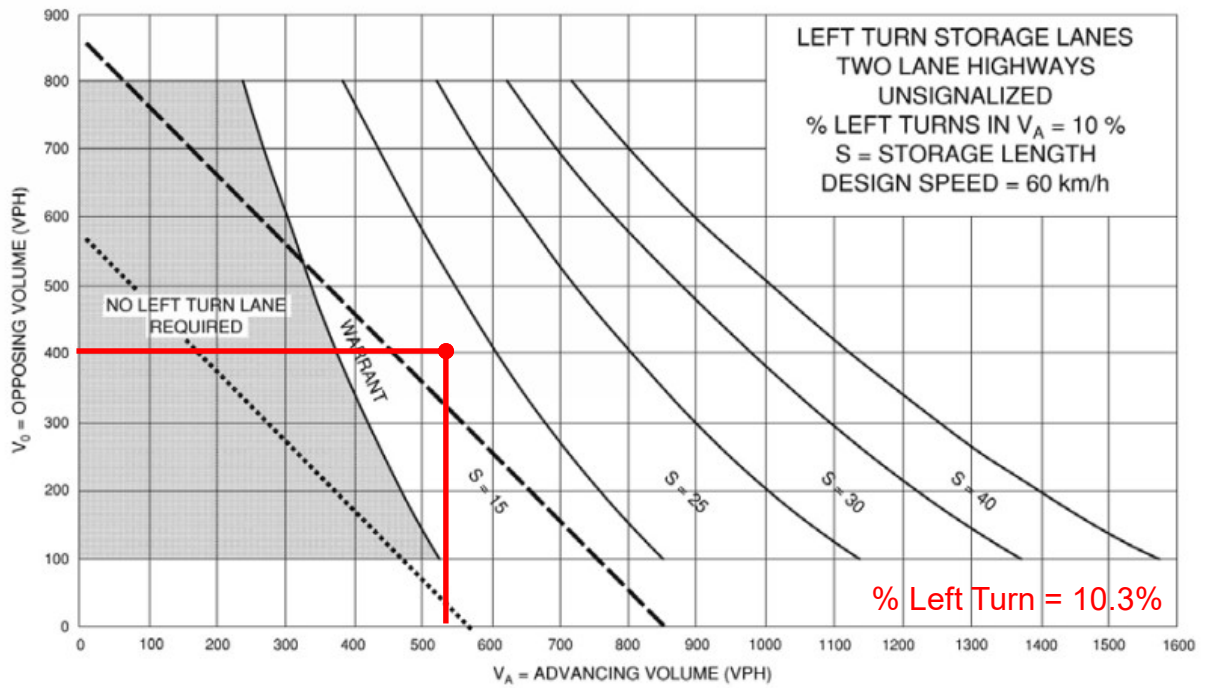

Existing (2022) PM Peak – WB on Moira St W at Tripp Ave

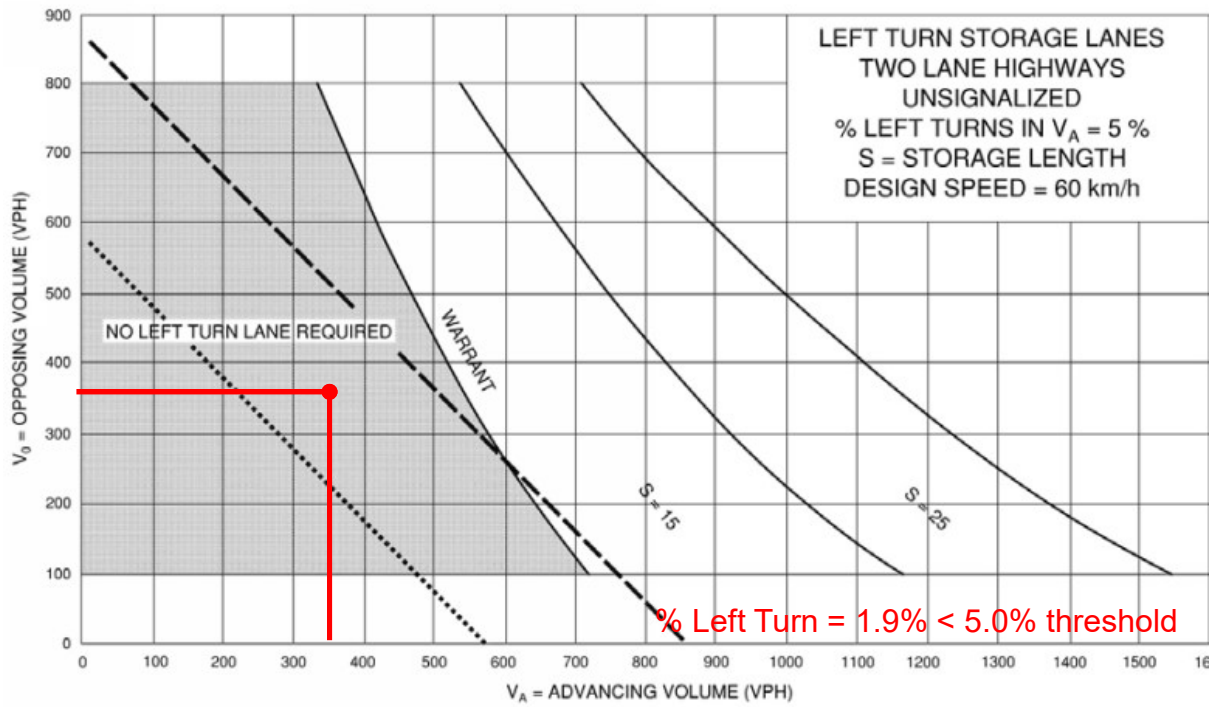

Existing (2022) AM Peak – WB on Moira St W at Elgin Ave

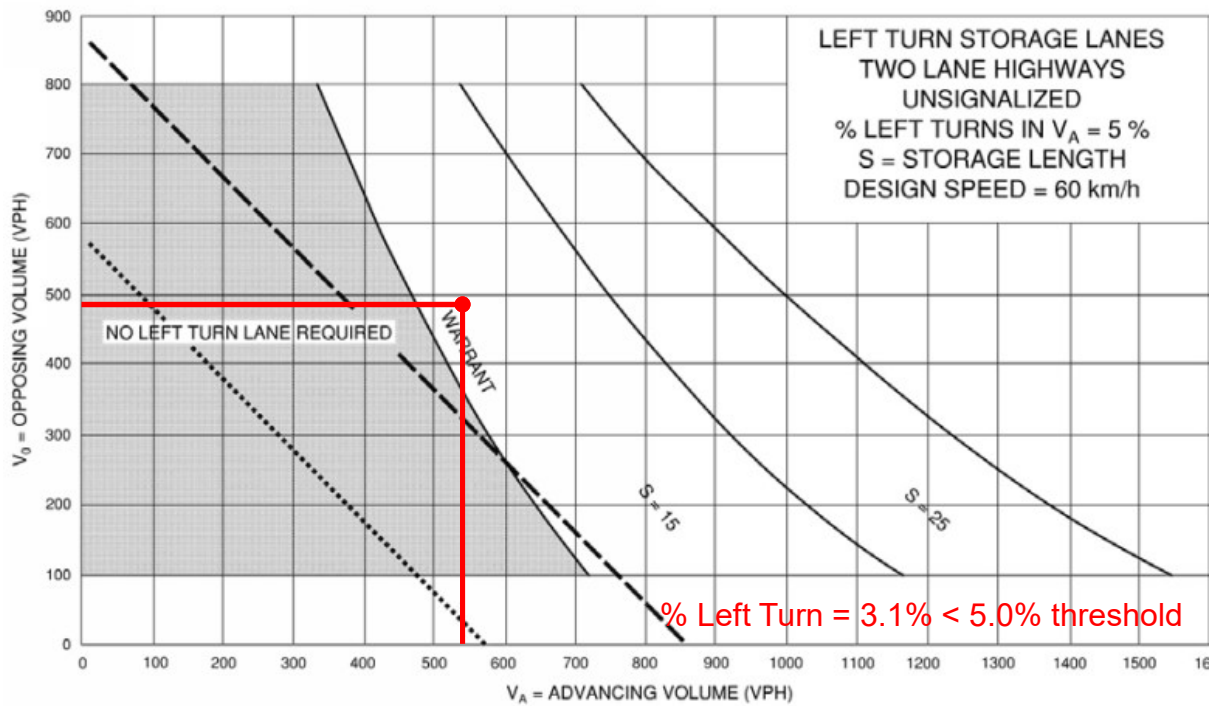

Existing (2022) PM Peak – WB on Moira St W at Elgin Ave

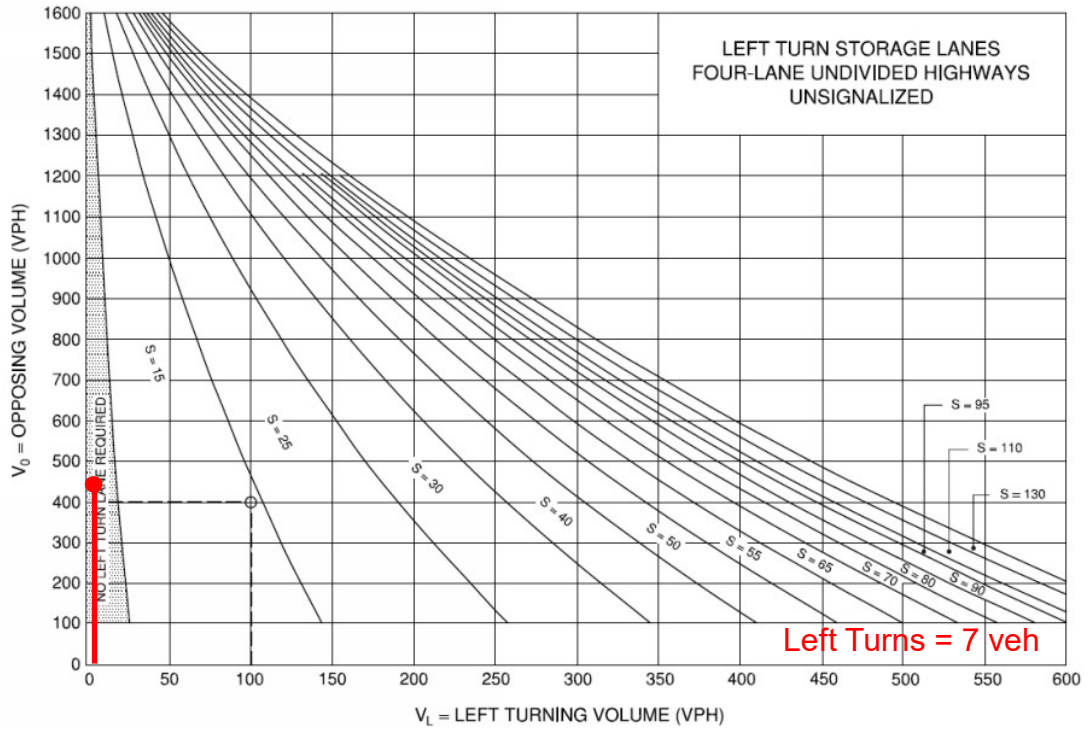

Existing (2022) AM Peak – NB on Sidney Street at Wilson Ave

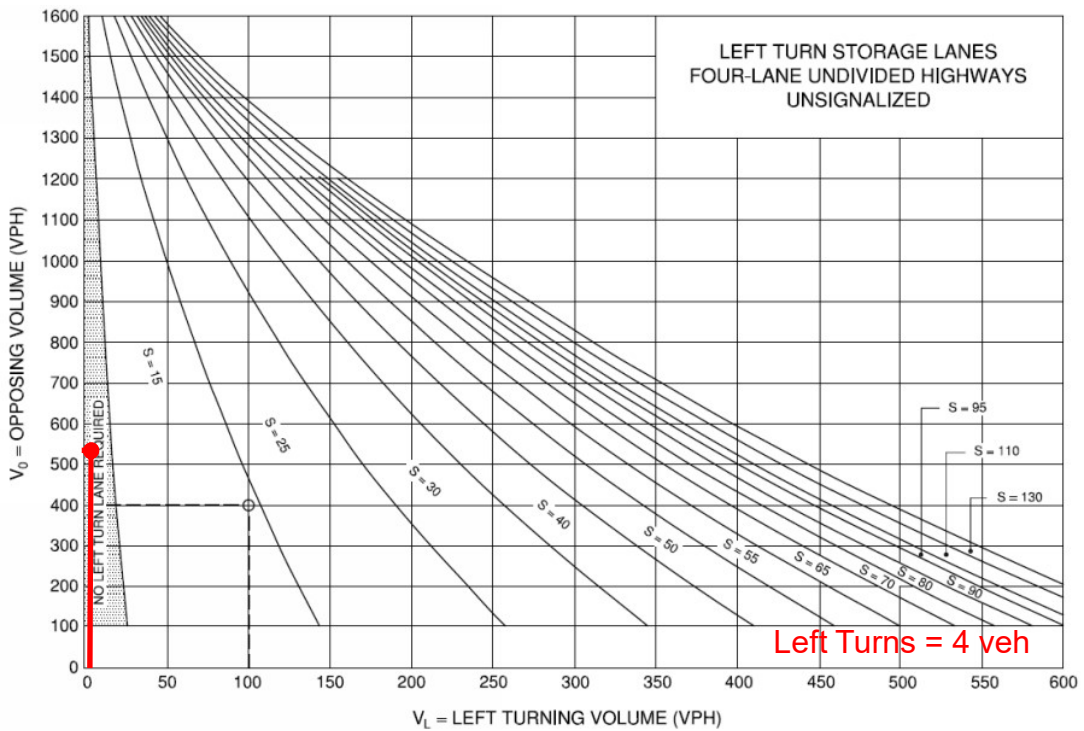

Existing (2022) PM Peak – NB on Sidney Street at Wilson Ave

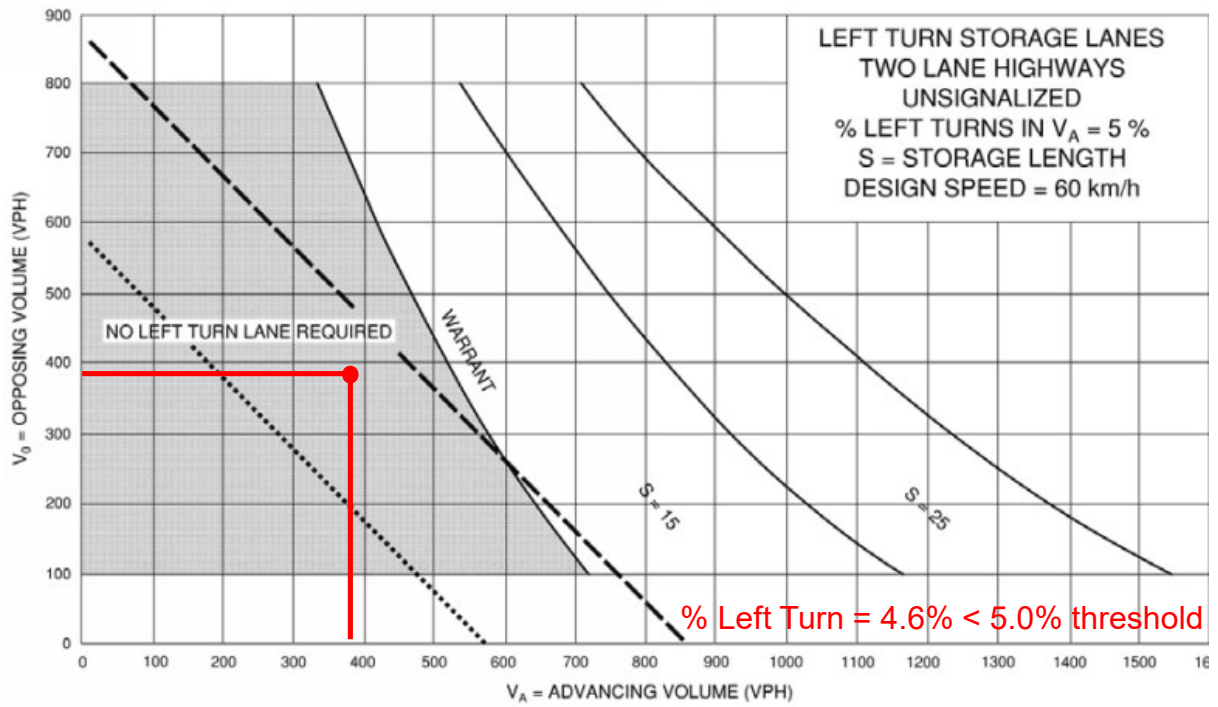

Background (2029) AM Peak – WB on Moira St W at Tripp Ave

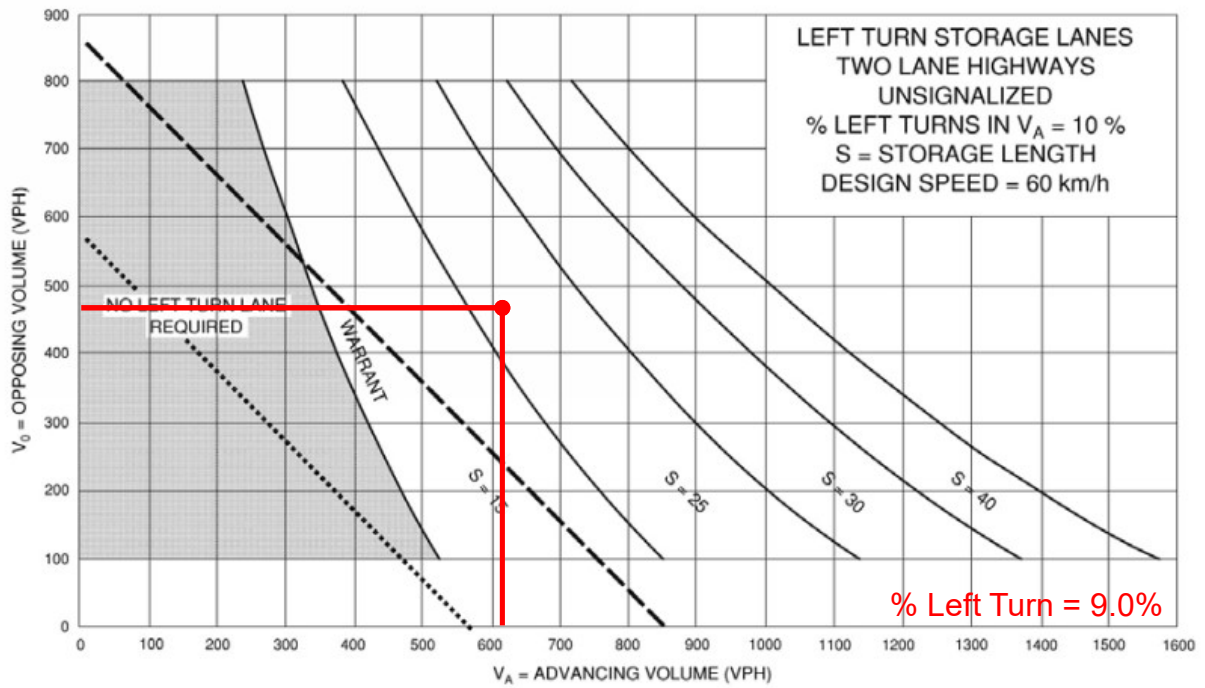

Background (2029) PM Peak – WB on Moira St W at Tripp Ave

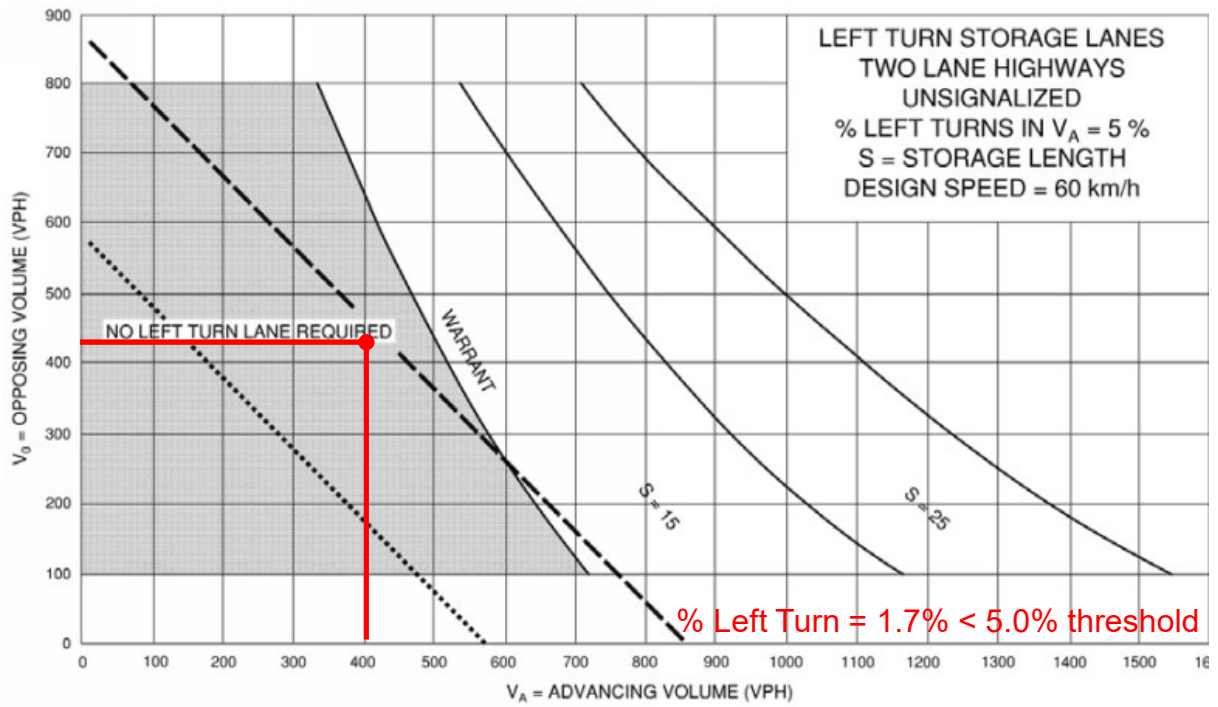

Background (2029) AM Peak – WB on Moira St W at Elgin Ave

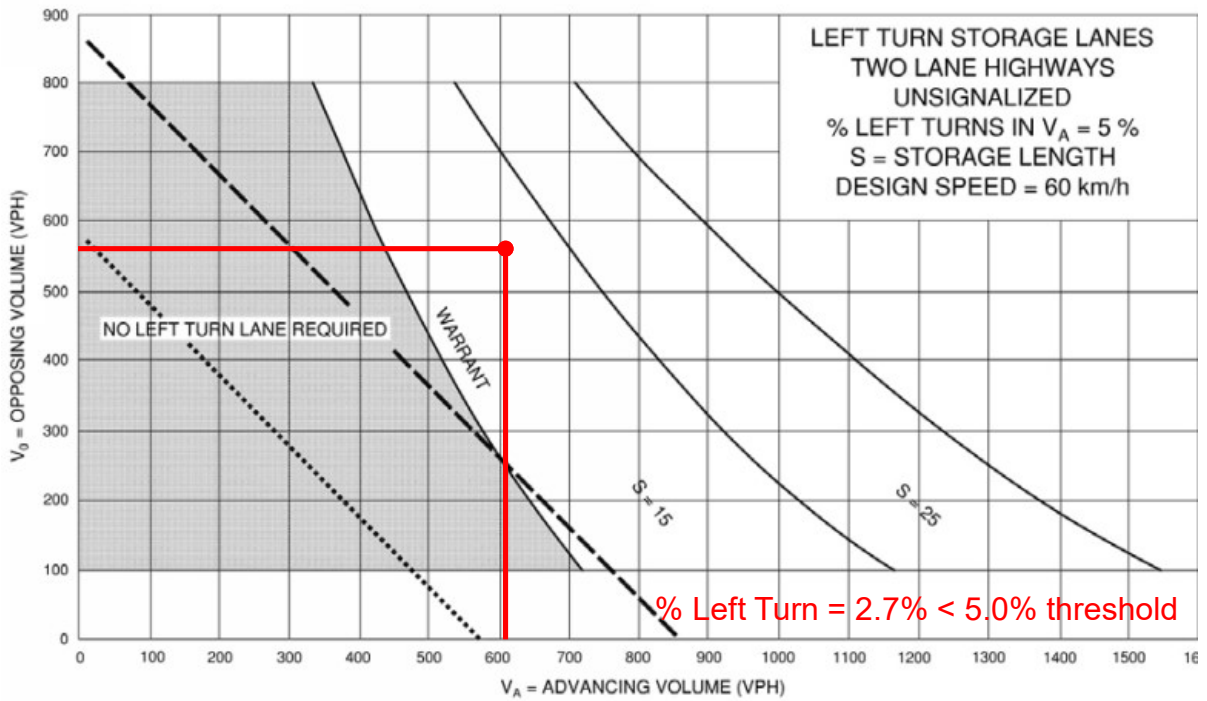

Background (2029) PM Peak – WB on Moira St W at Elgin Ave

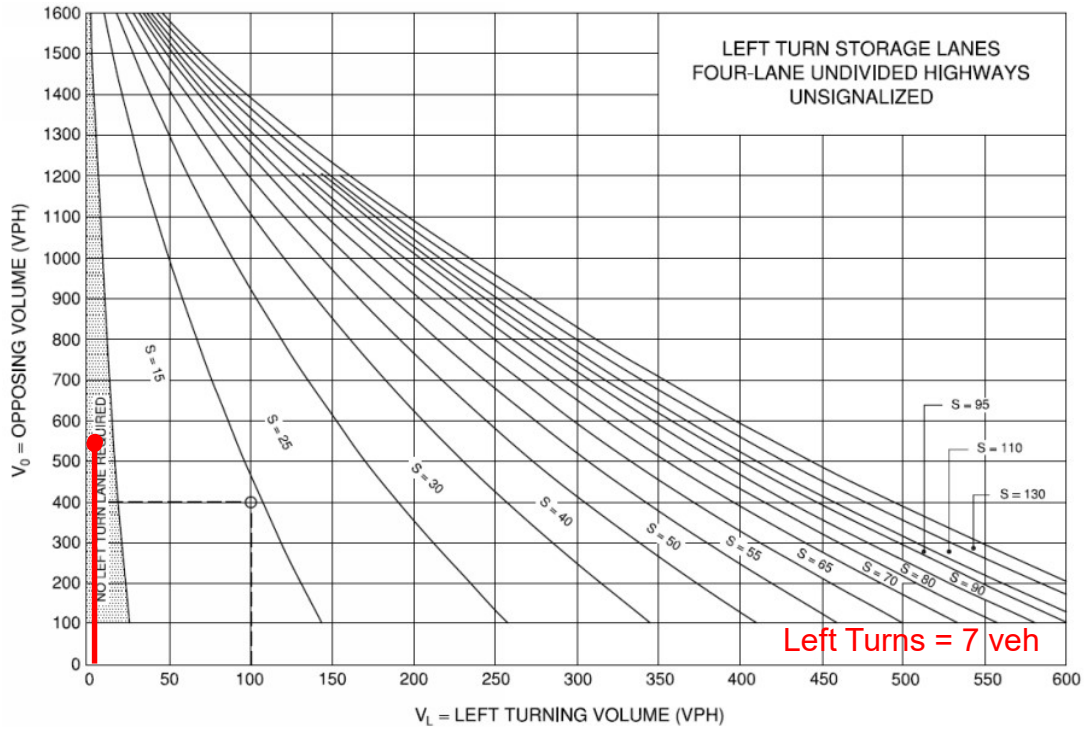

Background (2029) AM Peak – NB on Sidney Street at Wilson Ave

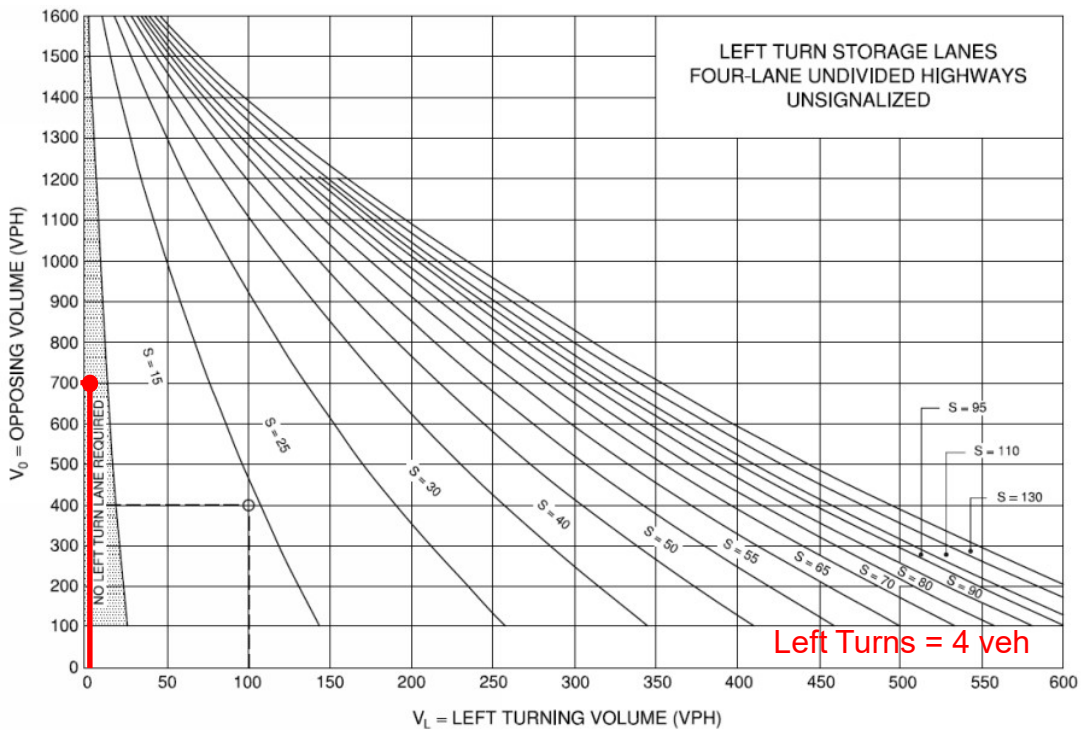

Background (2029) PM Peak – NB on Sidney Street at Wilson Ave

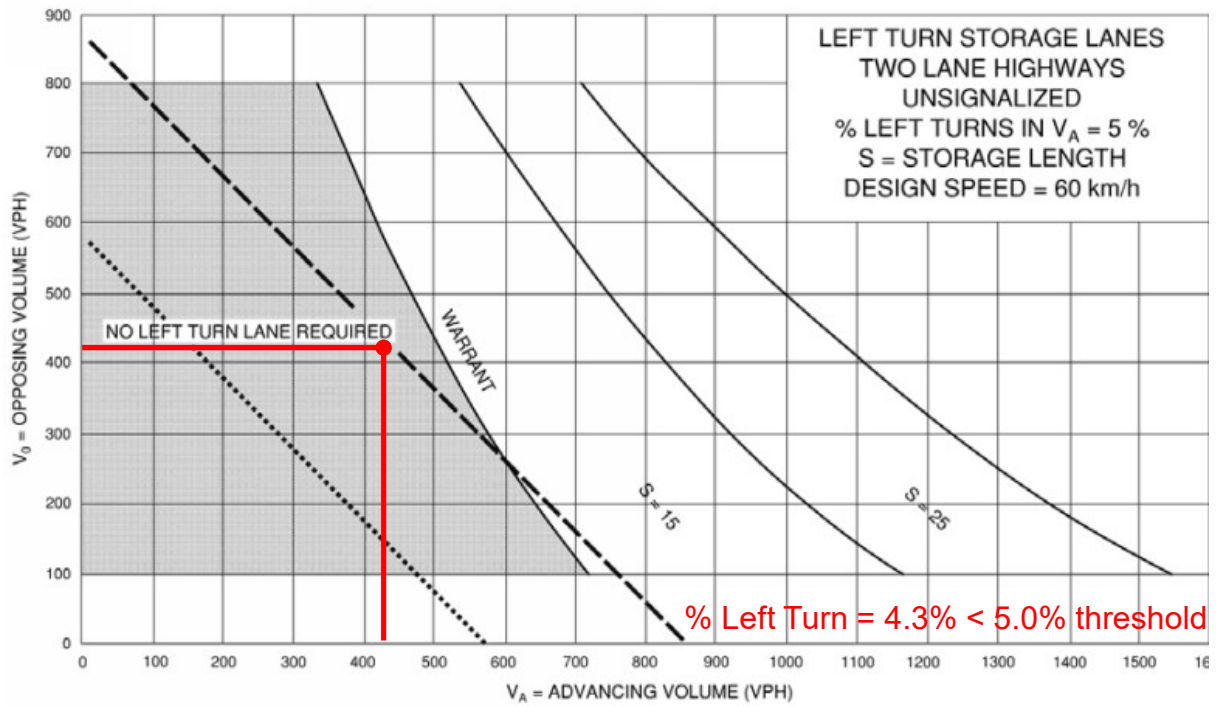

Background (2034) AM Peak – WB on Moira St W at Tripp Ave

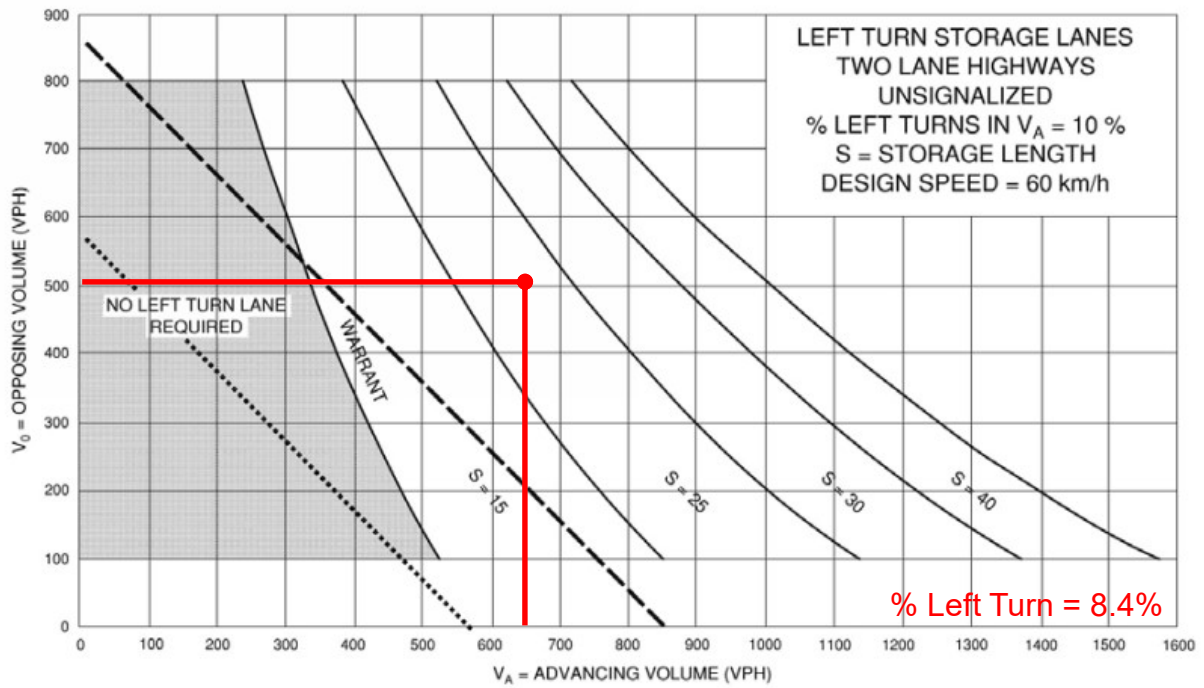

Background (2034) PM Peak – WB on Moira St W at Tripp Ave

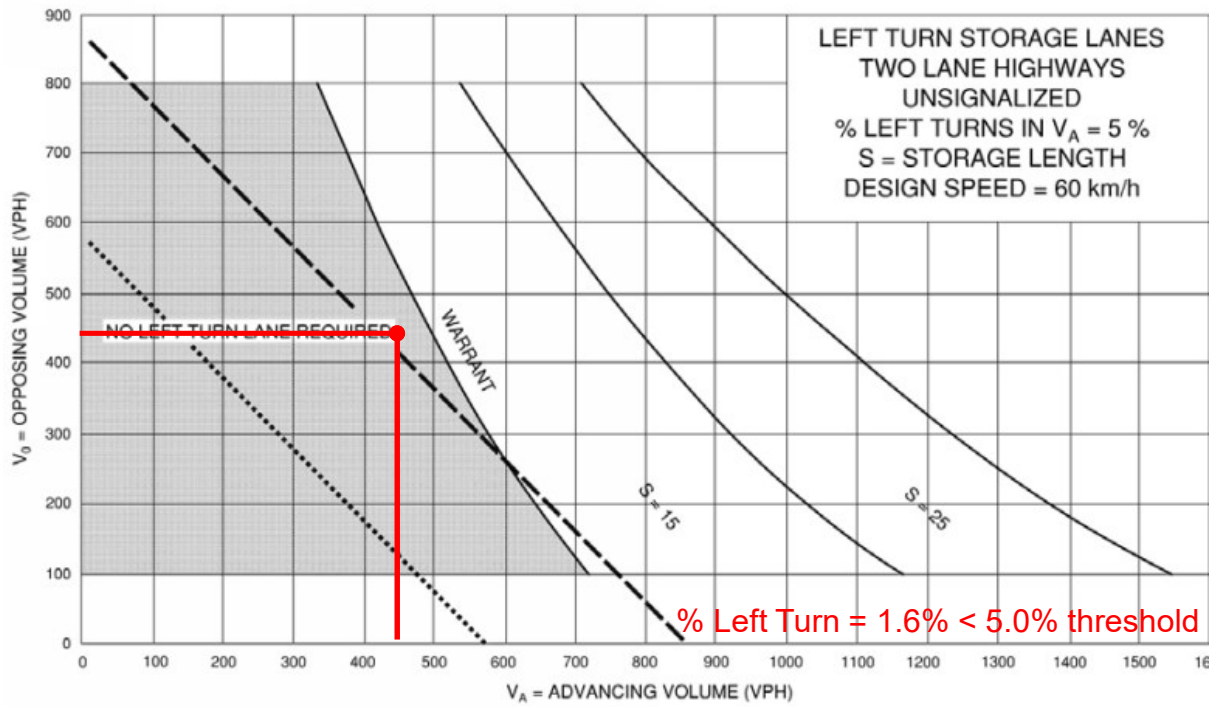

Background (2034) AM Peak – WB on Moira St W at Elgin Ave

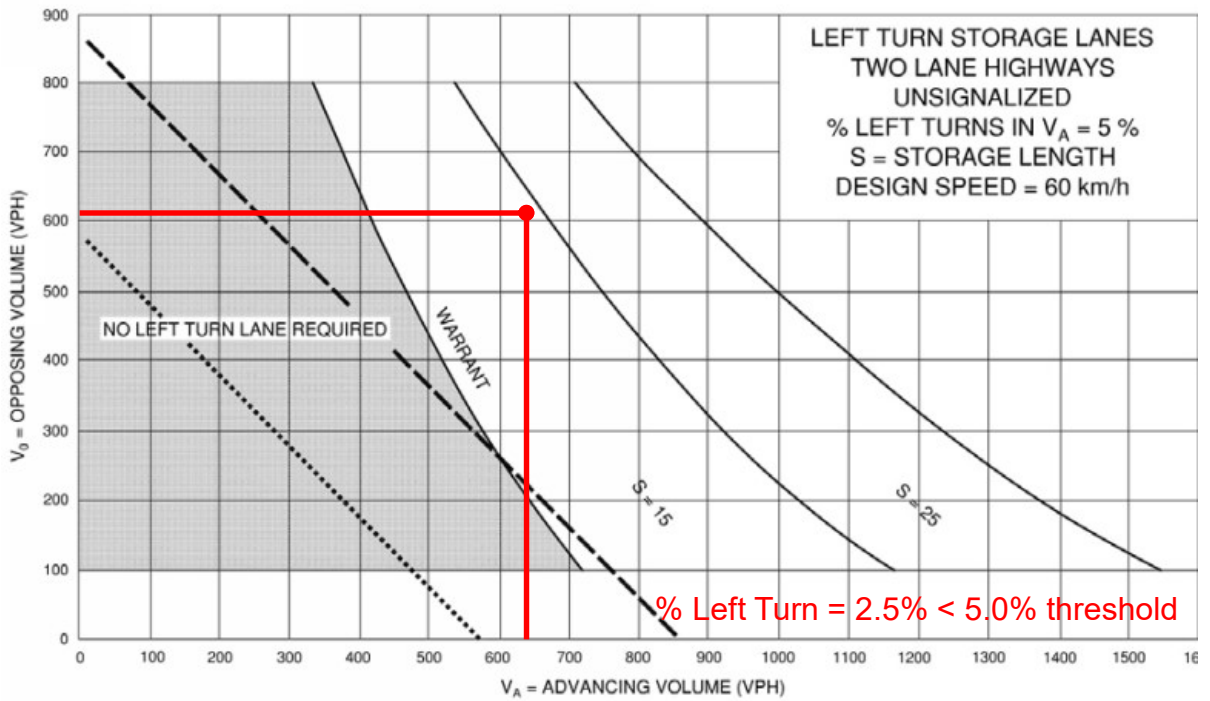

Background (2034) PM Peak – WB on Moira St W at Elgin Ave

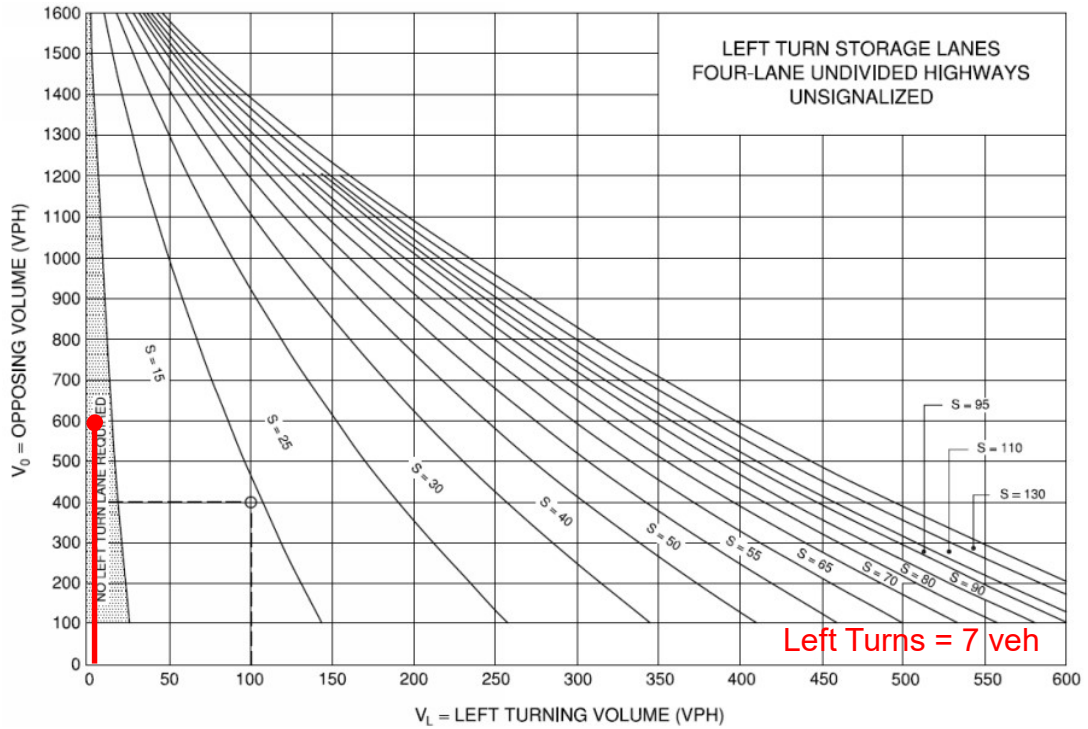

Background (2033) AM Peak – NB on Sidney Street at Wilson Ave

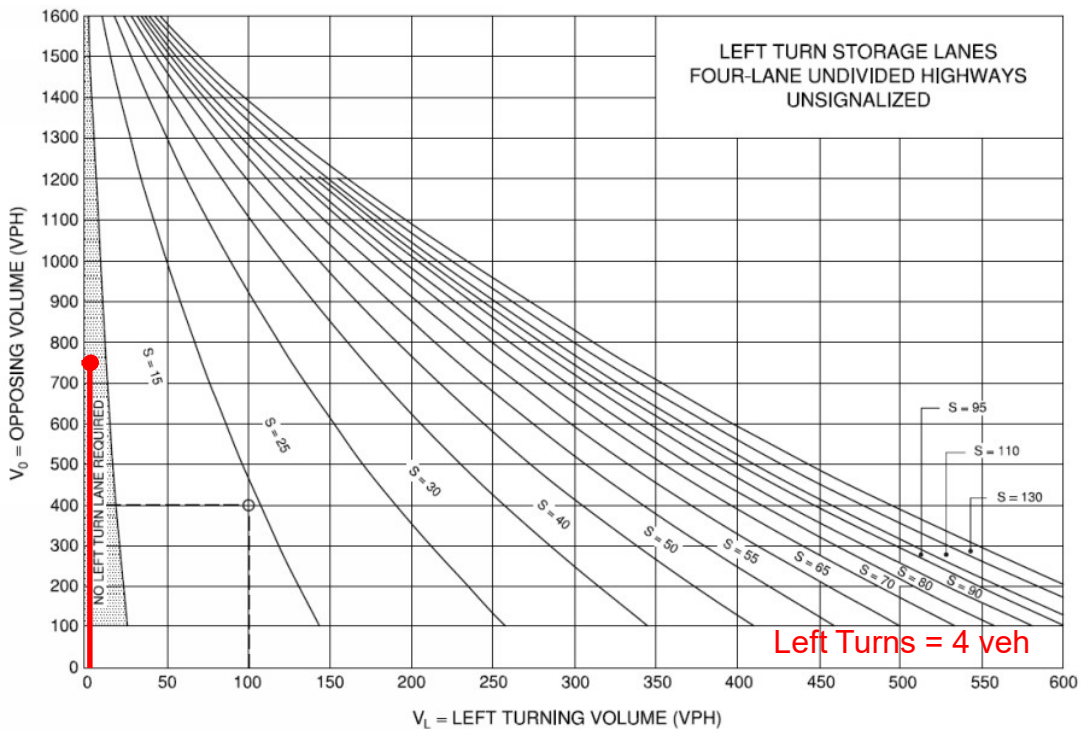

Background (2033) PM Peak – NB on Sidney Street at Wilson Ave

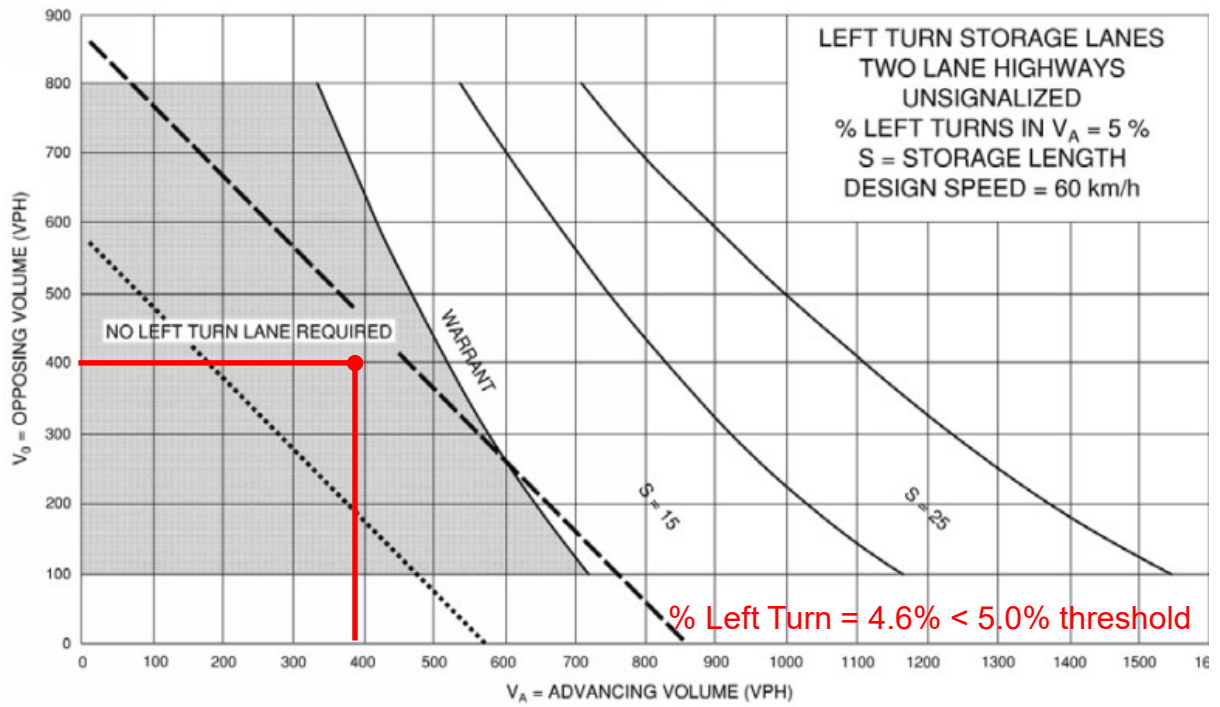

Total (2029) AM Peak – WB on Moira St W at Tripp Ave

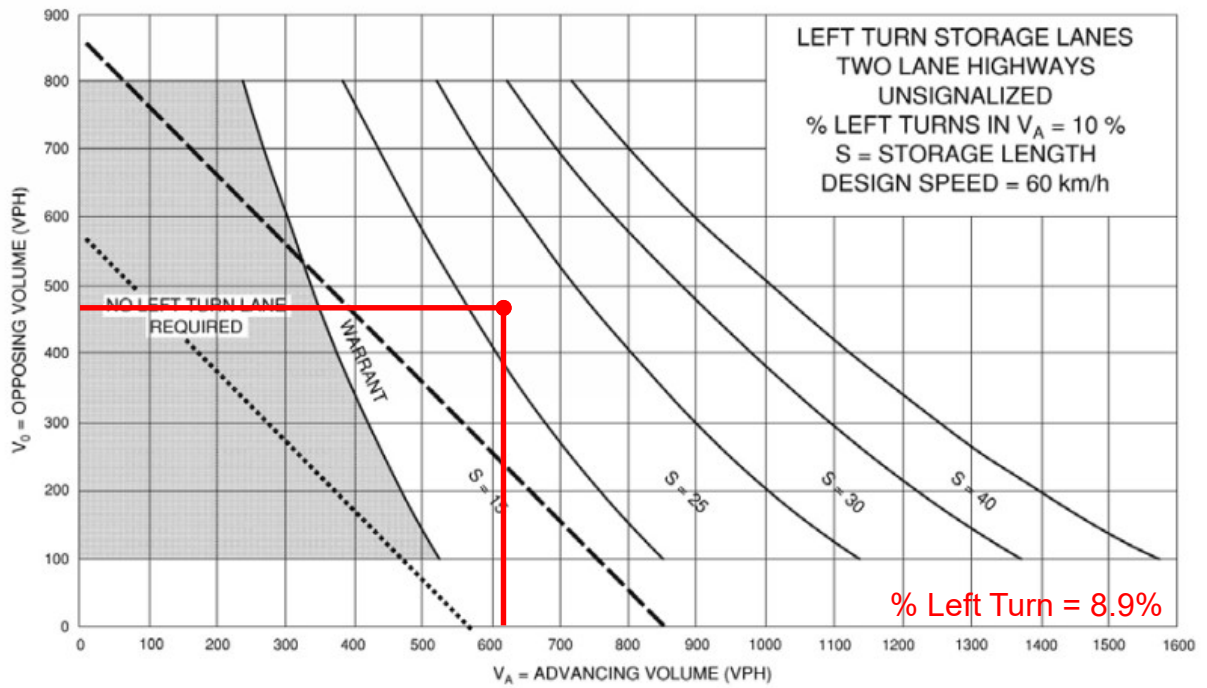

Total (2029) PM Peak – WB on Moira St W at Tripp Ave

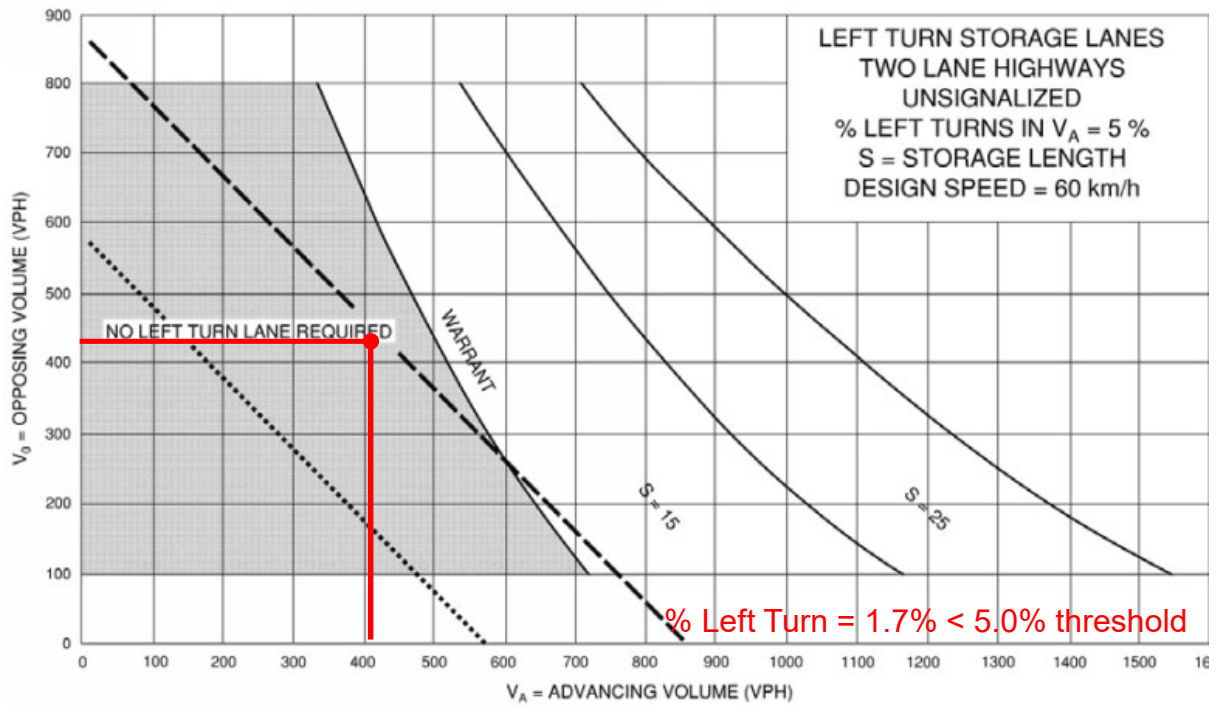

Total (2029) AM Peak – WB on Moira St W at Elgin Ave

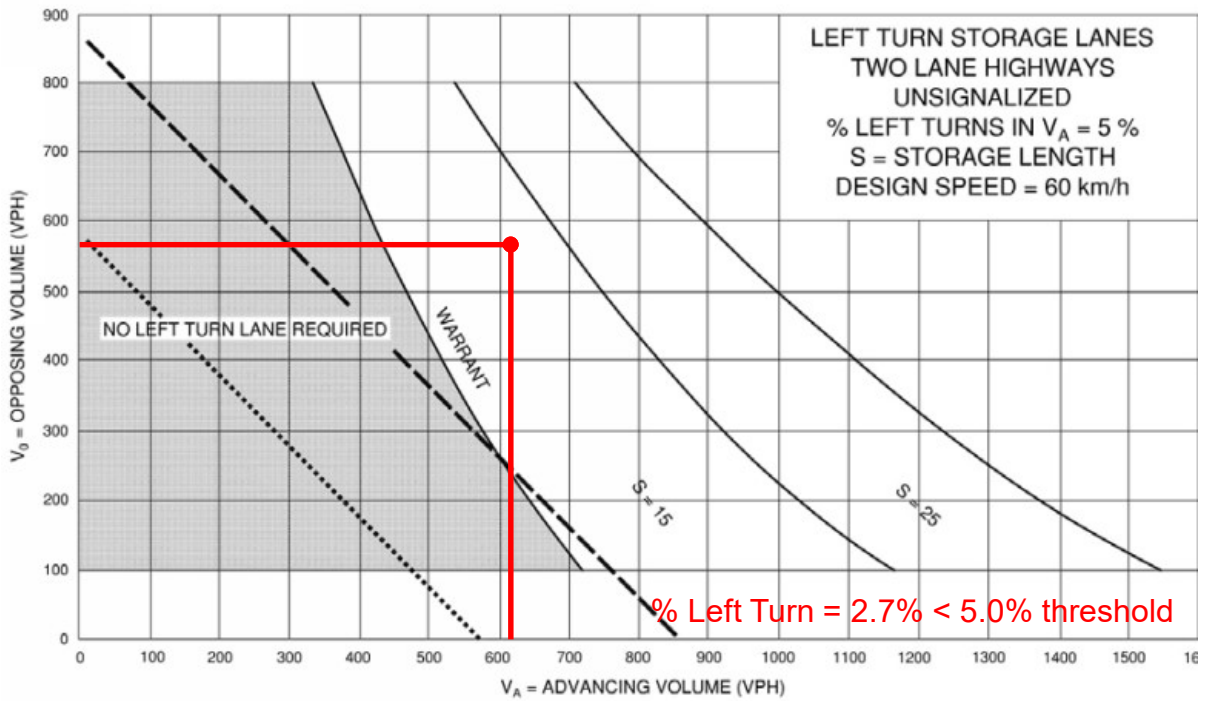

Total (2029) PM Peak – WB on Moira St W at Elgin Ave

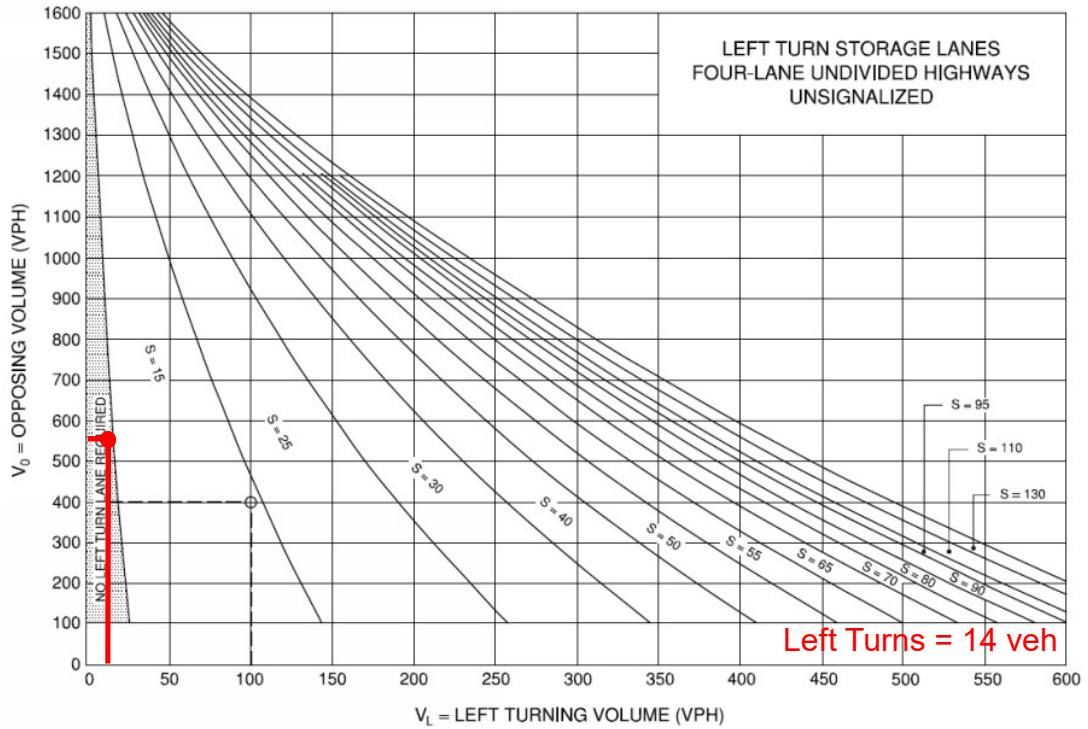

Total (2029) AM Peak – NB on Sidney Street at Wilson Ave

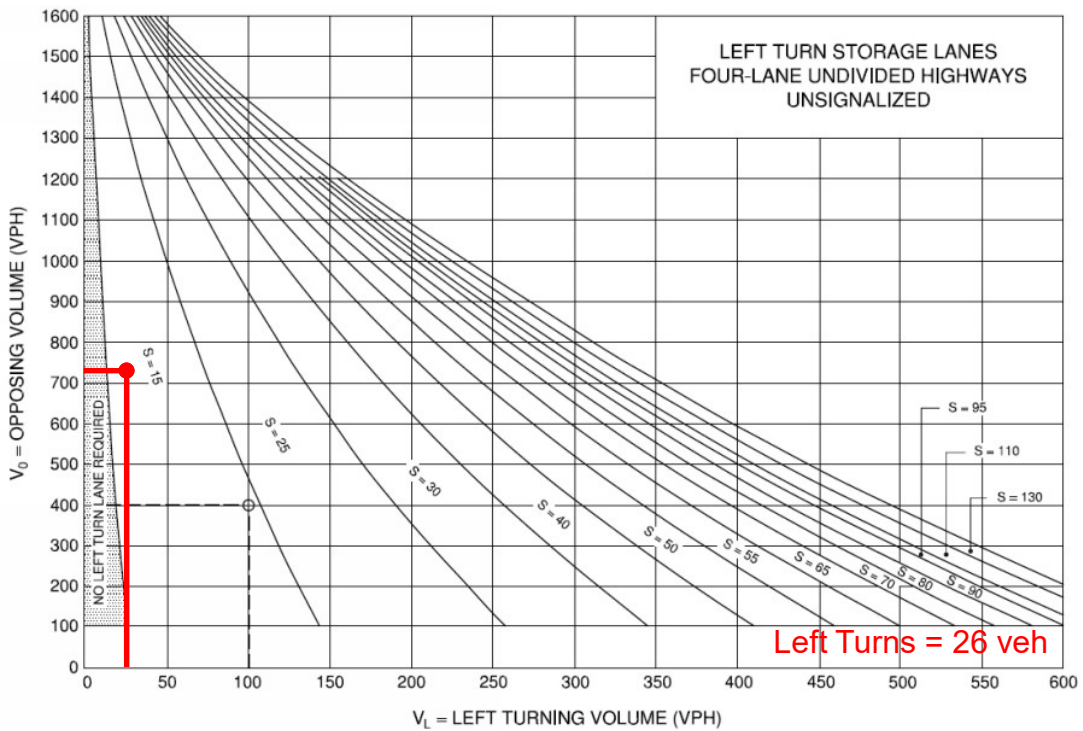

Total (2029) PM Peak – NB on Sidney Street at Wilson Ave

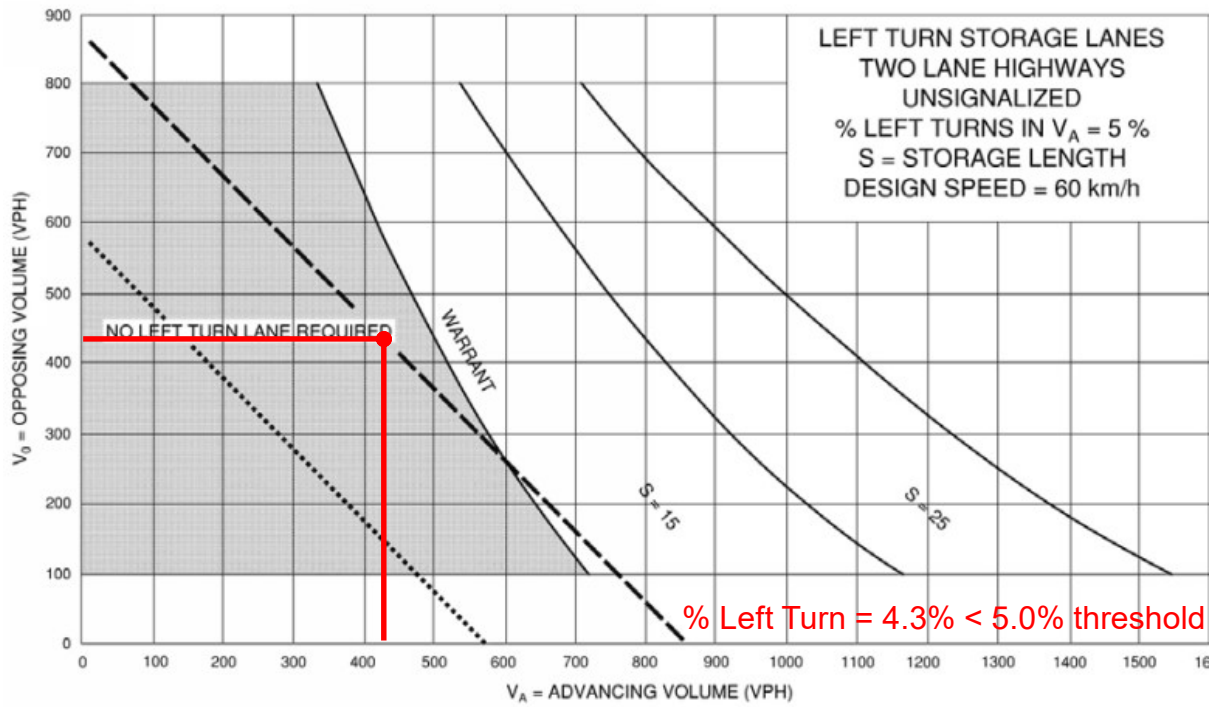

Total (2034) AM Peak – WB on Moira St W at Tripp Ave

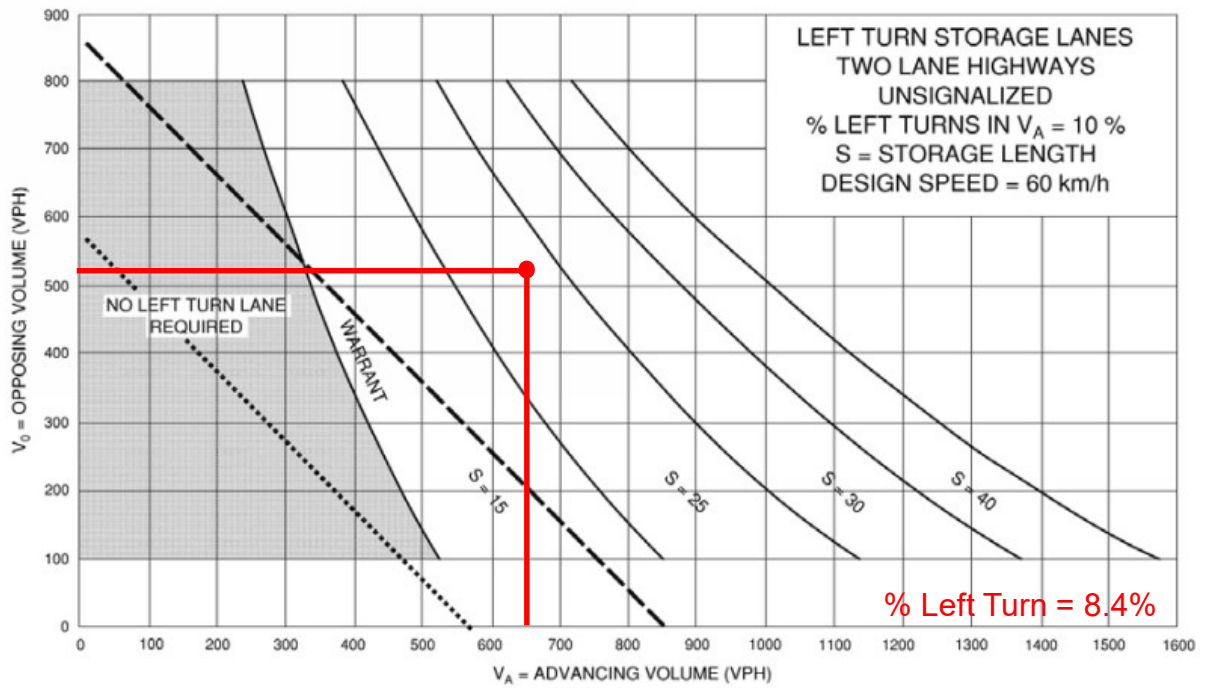

Total (2034) PM Peak – WB on Moira St W at Tripp Ave

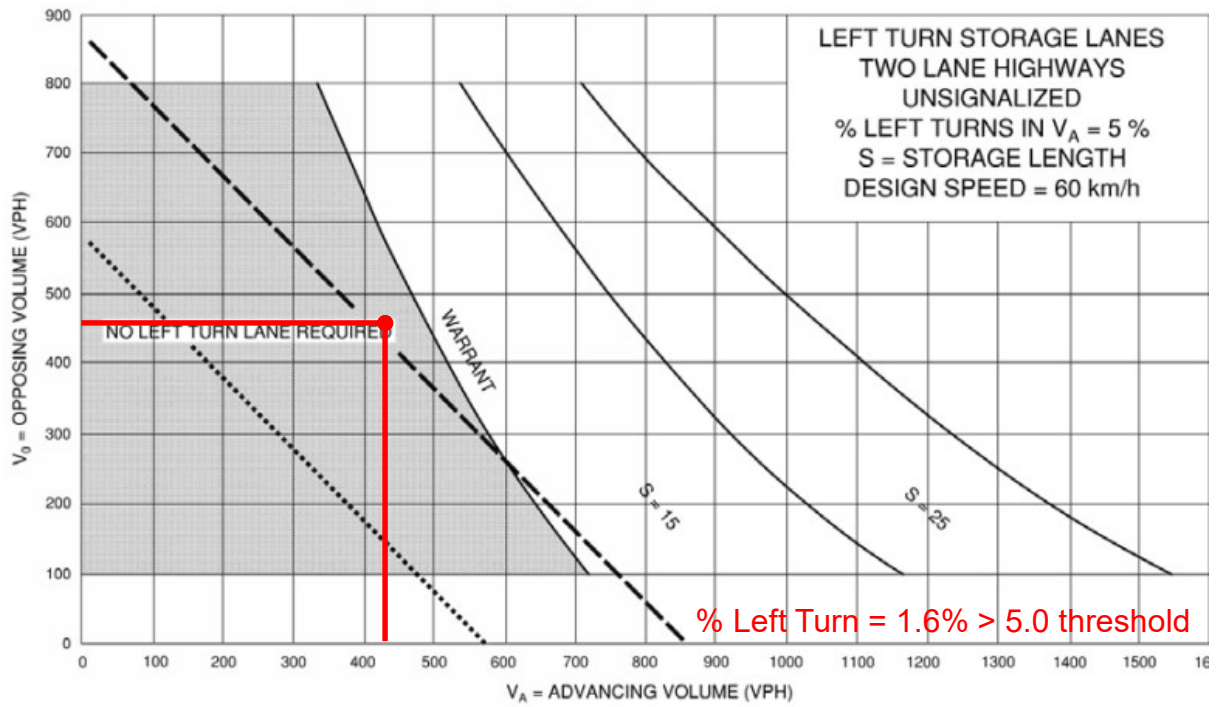

Total (2034) AM Peak – WB on Moira St W at Elgin Ave

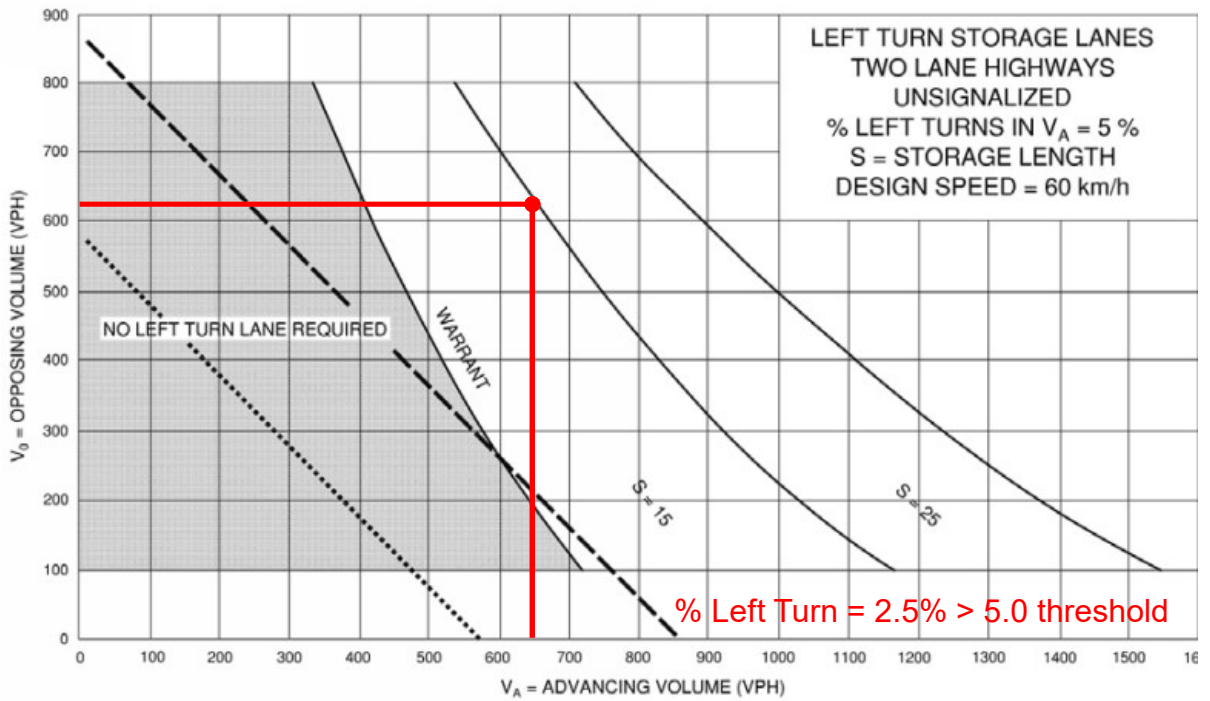

Total (2034) PM Peak – WB on Moira St W at Elgin Ave

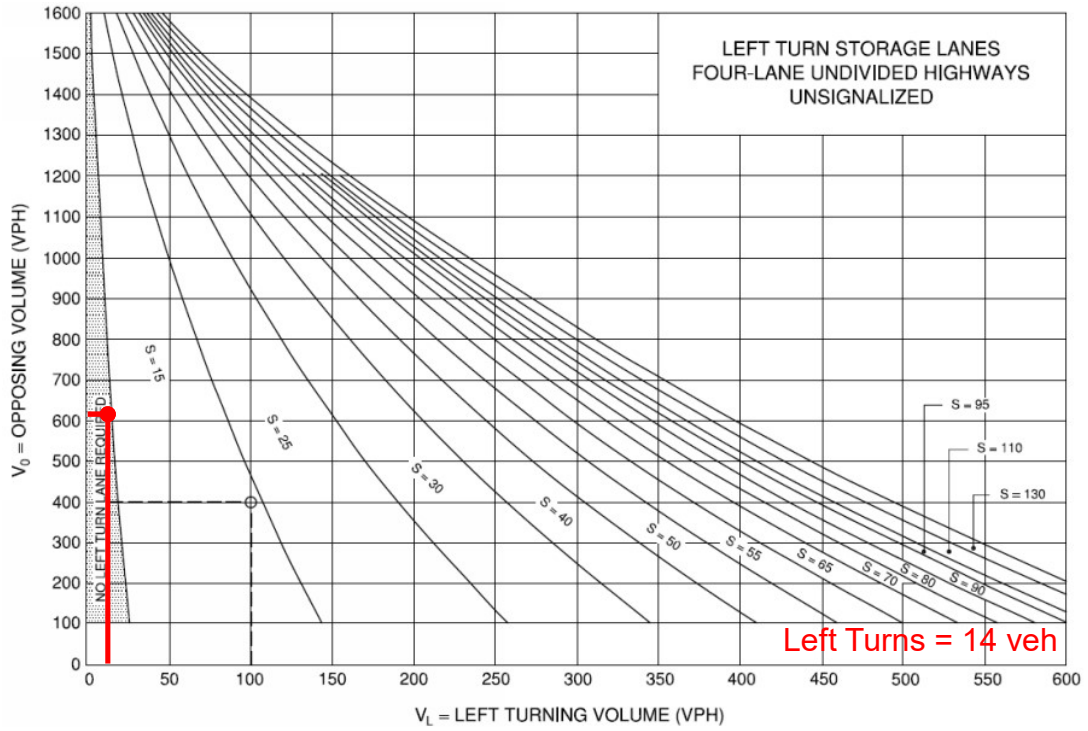

Total (2033) AM Peak – NB on Sidney Street at Wilson Ave

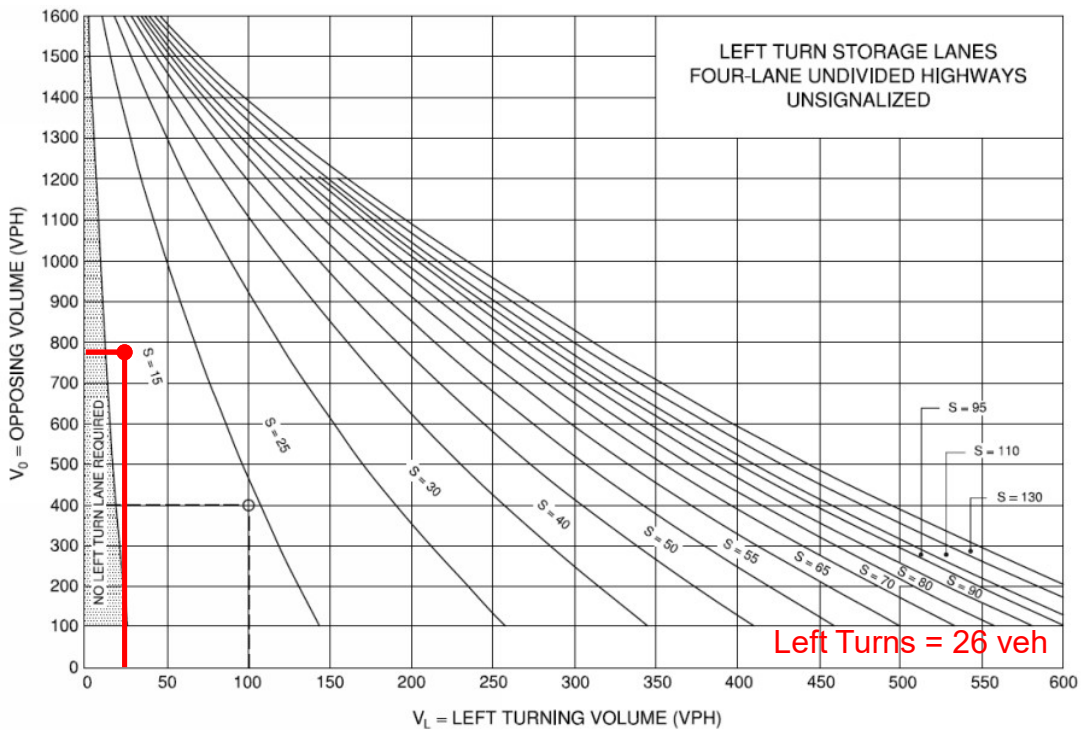

Total (2033) PM Peak – NB on Sidney Street at Wilson Ave

Appendix H – OTM Signal Justification Sheets

Justification No. 7 - Total (2034) Traffic

Moira St W / Trip Ave

Justification	Description	Rest. Flow	Compliance		Entire %	Signal Warrant	Underground Provisions Warrant
			Sectional				
			Numerical	%			
1. Minimum Vehicular Volume	A. Vehicle volume, all approaches (average hour)	720	523	73%	7%	NO	NO
	B. Vehicle volume, along minor streets (average hour)	255	21	8%		NO	NO
2. Delay to cross traffic	A. Vehicle volume, major street (average hour)	720	499	69%	1%	NO	NO
	B. Combined vehicle and pedestrian volume crossing artery from minor streets (average hour)	75	1	1%		NO	NO

Justification No. 7 - Total (2034) Traffic

Moira St W / Elgin St

Justification	Description	Compliance				Signal Warrant	Underground Provisions Warrant
		Rest. Flow	Sectional		Entire %		
			Numerical	%			
1. Minimum Vehicular Volume	A. Vehicle volume, all approaches (average hour)	720	558	78%	7%	NO	NO
	B. Vehicle volume, along minor streets (average hour)	255	21	8%		NO	NO
2. Delay to cross traffic	A. Vehicle volume, major street (average hour)	720	520	72%	11%	NO	NO
	B. Combined vehicle and pedestrian volume crossing artery from minor streets (average hour)	75	10	13%		NO	NO

Justification No. 7 - Total (2034) Traffic

Sidney St / Wilson Ave

Justification	Description	Rest. Flow	Compliance		Entire %	Signal Warrant	Underground Provisions Warrant
			Sectional				
			Numerical	%			
1. Minimum Vehicular Volume	A. Vehicle volume, all approaches (average hour)	900	800	89%	8%	NO	NO
	B. Vehicle volume, along minor streets (average hour)	255	25	10%		NO	NO
2. Delay to cross traffic	A. Vehicle volume, major street (average hour)	900	760	84%	6%	NO	NO
	B. Combined vehicle and pedestrian volume crossing artery from minor streets (average hour)	170	13	7%		NO	NO